

TARIFF SCHEDULES

Applicable to

NATURAL GAS SERVICE

of

SOUTHWEST GAS CORPORATION

SOUTHERN NEVADA DIVISION

Operating in the Counties of Clark and Lincoln

NORTHERN NEVADA DIVISION

Operating in the Counties of
Carson City, Churchill, Douglas, Elko, Eureka, Humboldt,
Lander, Lyon, Nye, Pershing, Storey and Washoe

These tariff schedules have been regularly filed with the Public Utilities Commission of Nevada and are the effective rates and rules of Southwest Gas Corporation (Company).

Service will be furnished in accordance with these tariff schedules and no officer, employee or representative of the Company has any authority to waive, alter or amend these tariff schedules or any parts thereof in any respect.

<p>Issued: August 8, 2018</p> <p>Effective: August 8, 2018</p> <p>Advice Letter No.:</p>	<p>Issued by Justin Lee Brown Senior Vice President</p>	
--	---	--

N

T
T

TABLE OF CONTENTS

The following listed sheets contain all of the effective rules and regulations affecting rates and service and information relating thereto in effect on and after the date indicated thereon:

<u>Title of Sheet</u>	<u>P.U.C.N. Sheet No.</u>
Title Page	1
Table of Contents	2 – 7
Preliminary Statement	8 – 9

STATEMENT OF RATES

Statement of Rates – Effective Rates Applicable to Southern Nevada Schedules	10 – 11A
Statement of Rates – Effective Rates Applicable to Northern Nevada Schedules	12 – 14
Statement of Rates – Other Service Charges	15

<p>Issued: December 16, 2020</p> <p>Effective: December 18, 2020</p> <p>Advice Letter No.:</p>	<p>Issued by Justin Lee Brown Senior Vice President</p>	
--	---	--

L

T
T

TABLE OF CONTENTS
(Continued)

NEVADA RATE SCHEDULES

<u>Schedule No.</u>		<u>P.U.C.N. Sheet No.</u>
SG-RS/NG-RS	Single-Family Residential Gas Service	16
SG-RM/NG-RM	Multi-Family Residential Gas Service	17
Held for Future Use		18
SG-RAC/NG-RAC	Air Conditioning Residential Gas Service	19 – 19A
SG-G1/NG-G1	General Gas Service - 1	20 – 22
SG-G2/NG-G2	General Gas Service - 2	23 – 25
SG-G3/NG-G3	General Gas Service - 3	26 – 28
SG-G4/NG-G4	General Gas Service - 4	29 – 31
SG-AC/NG-AC	Air-Conditioning Gas Service	32 – 34
SG-WP/NG-WP	Water Pumping Gas Service	35 – 37
SG-EG/NG-EG	Small Electric Generation Gas Service	38 – 40
SG-CNG/NG-CNG	Gas Service for Compression on Customer's Premises	41 – 43
SG-L/NG-L	Street and Outdoor Lighting Gas Service	44 – 47
SG-CGS/NG-CGS	Compression Gas Service	47A – 47I
SG-OS/NG-OS	Optional Gas Service	48 – 51
SG-AS/NG-AS	Alternative Sales Service	52 – 53

<p>Issued: December 31, 2018</p> <p>Effective: January 1, 2019</p> <p>Advice Letter No.:</p>	<p>Issued by Justin Lee Brown Senior Vice President</p>	
--	---	--

TABLE OF CONTENTS
(Continued)

NEVADA RATE SCHEDULES (Continued)

<u>Schedule No.</u>		<u>P.U.C.N. Sheet No.</u>
SG-RNG/NG-RNG	Biogas and Renewable Natural Gas Service	53A – 53I
SG-G5	General Gas Service – 5	53J – 53L
SG-G6	General Gas Service – 6	53M – 53O
Held For Future Use		53P – 53R
NG-G5	General Gas Service – 5	53S – 53U
ST-1/NT-1	Transportation of Customer-Secured Natural Gas	54 – 84
M2Z	Move2Zero Carbon Offset Program	84A-84B

SPECIAL SUPPLEMENTARY TARIFF PROVISIONS

<u>Title of Sheet</u>	<u>P.U.C.N. Sheet No.</u>
Interstate Pipeline Capacity Services Provision	85
Held For Future Use	86
Taxes and Assessments Not Included in Rates	87
General Revenues Adjustment Provision	88 – 89
Unrecovered Gas Cost Expense Provision	90 – 91
Contract Transition Adjustment Provision	91A1 – 91A2
Large Customer Adjustment Provision	91B1 – 91B2

<p>Issued: April 10, 2024</p> <p>Effective: April 15, 2024</p> <p>Advice Letter No.:</p>	<p>Issued by Amy L. Timperley Senior Vice President/ Chief Regulatory Strategy and Planning Officer</p>	
--	---	--

T
N

T
T

TABLE OF CONTENTS
(Continued)

SERVICE AREA MAPS AND DESCRIPTION OF SERVICE AREA

<u>Title of Sheet</u>	<u>P.U.C.N. Sheet No.</u>
<u>SOUTHERN NEVADA DIVISION</u>	
Clark County	92 – 94
Mesquite	95 – 95A
Primm	96 – 97
Boulder City	98 – 99
Fort Mohave Cal-	100 – 101A
Nev-Ari	102 – 102A
Transmission Area	103 – 109
<u>NORTHERN NEVADA DIVISION</u>	
Humboldt, Elko and Lander Counties	110 – 112
Humboldt and Pershing Counties	113 – 116
Carson City, Douglas, Lyon, Washoe, Storey and Churchill Counties	117 – 127
Transmission Area	128 – 133
Liquefied Natural Gas Plant Site Area	134 – 135

<p>Issued: August 8, 2018</p> <p>Effective: August 8, 2018</p> <p>Advice Letter No.:</p>	<p>Issued by Justin Lee Brown Senior Vice President</p>	
--	---	--

T
N

T
T

TABLE OF CONTENTS
(Continued)

RULES

<u>Rule No.</u>	<u>Title of Sheet</u>	<u>P.U.C.N. Sheet No.</u>
1	Definitions	136– 145A
2	Description of Service	146– 149A
3	Application for Service	150– 153A
4	Notices	154
5	Bills for Service	155 – 163
6	Discontinuance, Termination, Restoration and Refusal of Service	164 – 175
7	Information Available to the Public	176 – 177
8	Continuity of Service	178– 180
9	Facilities Extensions	181 – 193
10	Held for Future Use	194 – 202
11	Information on Forms	203
12	Establishment and Reestablishment of Credit	204 – 207
13	Deposits	208 – 212
14	Disputed Bills	213
15	Temporary Service	214

<p>Issued: December 31, 2018</p> <p>Effective: January 1, 2019</p> <p>Advice Letter No.:</p>	<p>Issued by Justin Lee Brown Senior Vice President</p>	
--	---	--

TABLE OF CONTENTS

(Continued)

RULES

(Continued)

<u>Rule No.</u>	<u>Title of Sheet</u>	<u>P.U.C.N. Sheet No.</u>
16	Facilities on Customer's Premises	215 – 217D
17	Meter Tests and Adjustment of Bills	218 – 220
18	Supply to Separate Premises and Resale	221 – 222
19	Service Agreements	223
20	Examination and Testing of Lines and Equipment in Mobile Home Parks	224 – 225

<p>Issued: December 31, 2018</p> <p>Effective: January 1, 2019</p> <p>Advice Letter No.:</p>	<p>Issued by Justin Lee Brown Senior Vice President</p>	
--	---	--

PRELIMINARY STATEMENT

The Company is certified to render gas service in those portions of Carson City, Churchill, Clark, Douglas, Elko, Eureka, Humboldt, Lander, Lincoln, Lyon, Nye, Pershing, Storey and Washoe Counties as fully described on the sheets entitled "Description of Service Area" and as shown on the maps entitled "Distribution Service Area."

These Rules and Regulations are designed to govern the supplying and taking of gas service in such manner as will secure to each customer the greatest practicable latitude in the enjoyment of service, consistent with good service to each customer and with safety to all customers and the Company.

These Rules and Regulations are on file with the Public Utilities Commission of Nevada and copies are available at all Company offices. They are a part of every contract for service and govern all classes of service, except where specific provisions in contracts or schedules modify same. All prior rules, customs or alleged understandings are hereby rescinded. These tariff schedules are available for review by any customer at any office of the Company.

The Company has revised its Nevada Gas Tariff to comply with the provisions contained in the Consumer Bill of Rights which was promulgated by Order of the Public Service Commission of Nevada, predecessor of the Public Utilities Commission of Nevada, and became effective on January 5, 1989. To the extent the provisions of this Nevada Gas Tariff are determined by final order of the Public Utilities Commission of Nevada to be inconsistent with the provisions of the Consumer Bill of Rights, the provisions of the Consumer Bill of Rights will apply. Any inconsistency will be resolved in accordance with applicable statutes.

When any change is proposed to these tariff schedules, attention shall be directed to such change on the tariff sheet(s) filed with the Public Utilities Commission of Nevada by the symbols as set forth below:

- (C) To signify changed listing, rule or condition which may affect rates or charges.
- (D) To signify discontinued material, including listing, rate, rule or condition.
- (I) To signify increase.

<p>Issued: August 8, 2018</p> <p>Effective: August 8, 2018</p> <p>Advice Letter No.:</p>	<p>Issued by Justin Lee Brown Senior Vice President</p>	
--	---	--

N

T
T

PRELIMINARY STATEMENT

(Continued)

- (L) To signify material relocated from or to another part of tariff schedules with no change in text, rate, rule or condition.
- (N) To signify new material, including listing, rate, rule or condition.
- (R) To signify reduction.
- (T) To signify change in wording of text, but not change in rate, rule or condition.

<p>Issued: November 10, 2009</p> <p>Effective: November 1, 2009</p> <p>Advice Letter No.:</p>	<p>Issued by John P. Hester Senior Vice President</p>	
---	---	--

STATEMENT OF RATES
EFFECTIVE RATES APPLICABLE TO SOUTHERN NEVADA SCHEDULES ^{1/2/}

Schedule Number	Description	Delivery Charge ^{3/}	Gas Cost			Renewable Energy Program Rate	Infrastructure Expansion Rate ^{7/}	Currently Effective Tariff Rate	
			Base Tariff Energy Rate ^{4/}	Deferred Energy Account Adjustment					
SG-RS	Single-Family Residential Gas Service								
	Basic Service Charge per Month	\$ 10.80						\$ 10.80	
	Commodity Charge per Therm:								
	All Usage	\$.62107	\$.96165	\$.26528	\$.00000	\$.00126	\$ 1.84926		R
SG-RM	Multi-Family Residential Gas Service								
	Basic Service Charge per Month	\$ 9.00						\$ 9.00	
	Commodity Charge per Therm:								
	All Usage	\$.60201	\$.96165	\$.26528	\$.00000	\$.00126	\$ 1.83020		R
SG-RAC	Air Conditioning Residential Gas Service								
	Basic Service Charge per Month	\$ 10.80						\$ 10.80	
	Commodity Charge per Therm:								
	All Usage	\$.16920	\$.96165	\$.26528	\$.00000	\$.00126	\$ 1.39739		I
SG-G1	General Gas Service - 1								
	Basic Service Charge per Month	\$ 25.80						\$ 25.80	
	Commodity Charge per Therm:								
	All Usage	\$.30625	\$.96165	\$.26528	\$.00000	\$.00126	\$ 1.53444		R
SG-G2	General Gas Service - 2								
	Basic Service Charge per Month	\$ 135.00						\$ 135.00	
	Commodity Charge per Therm:								
	All Usage	\$.13476	\$.96165	\$.26528	\$.00000	\$.00126	\$ 1.36295		R
SG-G3	General Gas Service - 3								
	Basic Service Charge per Month	\$ 350.00						\$ 350.00	
	Commodity Charge per Therm:								
	All Usage	\$.11408	\$.96165	\$.26528	\$.00000	\$.00126	\$ 1.34227		R
SG-G4	General Gas Service - 4								
	Basic Service Charge per Month	\$1,000.00						\$1,000.00	
	Commodity Charge per Therm:								
	All Usage	\$.10156	\$.96165	\$.26528	\$.00000	\$.00126	\$ 1.32975		I
	Demand Charge ^{5/}	\$.03422					\$.03422		

<p>Issued:</p> <p align="center">May 3, 2024</p> <p>Effective:</p> <p align="center">May 1, 2024</p> <p>Advice Letter No.:</p>	<p>Issued by</p> <p>Amy L. Timperley Senior Vice President/ Chief Regulatory Strategy and Planning Officer</p>	
--	--	--

STATEMENT OF RATES
EFFECTIVE RATES APPLICABLE TO SOUTHERN NEVADA SCHEDULES ^{1/2/}

Schedule Number	Description	Delivery Charge ^{3/}	Gas Cost			Renewable Energy Program Rate	Infrastructure Expansion Rate ^{7/}	Currently Effective Tariff Rate
			Base Tariff Energy Rate ^{4/}	Deferred Energy Account Adjustment				
<u>SG-G5</u>	<u>General Gas Service - 5 ^{8/}</u>							
	Basic Service Charge per Month	\$1,000.00						\$1,000.00
	Commodity Charge per Therm:							
	All Usage	\$.02688	\$.96165	\$.26528	\$.00000	\$.00126	\$ 1.25507	
	Demand Charge ^{5/}	\$.00373					\$.00373	
<u>SG-G6</u>	<u>General Gas Service - 6 ^{8/}</u>							
	Basic Service Charge per Month	\$1,000.00						\$1,000.00
	Commodity Charge per Therm:							
	All Usage	\$.04978	\$.96165	\$.26528	\$.00000	\$.00126	\$ 1.27797	
	Demand Charge ^{5/}	\$.02416					\$.02416	
<u>SG-AC</u>	<u>Air Conditioning Gas Service</u>							
	Basic Service Charge per Month	\$ 25.80						\$ 25.80
	Commodity Charge per Therm:							
	All Usage	\$.14314	\$.96165	\$.26528	\$.00000	\$.00126	\$ 1.37133	
<u>SG-WP</u>	<u>Water Pumping Gas Service</u>							
	Basic Service Charge per Month	\$ 250.00						\$ 250.00
	Commodity Charge per Therm:							
	All Usage	\$.12402	\$.96165	\$.26528	\$.00000	\$.00126	\$ 1.35221	
<u>SG-EG</u>	<u>Small Electric Generation Gas Service</u>							
	Basic Service Charge per Month		Otherwise Applicable Rate Schedule					
	Commodity Charge per Therm:							
	All Usage	\$.08511	\$.96165	\$.26528	\$.00000	\$.00126	\$ 1.31330	

<p>Issued:</p> <p align="center">May 3, 2024</p> <p>Effective:</p> <p align="center">May 1, 2024</p> <p>Advice Letter No.:</p>	<p>Issued by</p> <p>Amy L. Timperley</p> <p>Senior Vice President/ Chief Regulatory Strategy and Planning Officer</p>	
--	--	--

STATEMENT OF RATES
EFFECTIVE RATES APPLICABLE TO SOUTHERN NEVADA SCHEDULES ^{1/2/}

Schedule Number	Description	Delivery Charge ^{3/}	Gas Cost			Renewable Energy Program Rate	Infrastructure Expansion Rate ^{7/}	Currently Effective Tariff Rate
			Base Tariff Energy Rate ^{4/}	Deferred Energy Account Adjustment				
SG-CNG	Gas Service for Compression on Customer's Premises ^{6/}							
	Basic Service Charge per Month	\$ 25.80						\$ 25.80
	Commodity Charge per Therm:							
	All Usage	\$.15256	\$.96165	\$.26528	\$.00000	\$.00126		\$ 1.38075
SG-L	Street and Outdoor Lighting Gas Service							
	Commodity Charge per Therm:							
	All Usage	\$.64010	\$.96165	\$.26528	\$.00000	\$.00126		\$ 1.86829
SG-OS	Optional Gas Service							
								As specified on Sheet Nos. 48 through 51.
SG-AS	Alternative Sales Service							
								As specified on Sheet Nos. 52 through 53.
SG-CGS	Compression Gas Service							
								As specified on Sheet Nos. 47A through 47I
SG-RNG	Biogas and Renewable Natural Gas Service							
								As specified on Sheet Nos. 53A through 53I

<p>Issued:</p> <p align="center">May 3, 2024</p> <p>Effective:</p> <p align="center">May 1, 2024</p> <p>Advice Letter No.:</p>	<p>Issued by</p> <p>Amy L. Timperley</p> <p>Senior Vice President/ Chief Regulatory Strategy and Planning Officer</p>	
--	--	--

STATEMENT OF RATES
EFFECTIVE RATES APPLICABLE TO SOUTHERN NEVADA SCHEDULES ^{1/2/}
(Continued)

- 1/ The charges shown above are subject to adjustments for taxes and assessments.
- 2/ Customers taking transportation service will pay the Basic Service Charge, the Delivery Charge per therm excluding the Conservation and Energy Efficiency component, and Demand Charge, if applicable, of the Currently Effective Tariff Rate for each meter included in the transportation service agreement, plus an amount for distribution system shrinkage for all volumes of gas not delivered through a direct connection to one of the Company's upstream interstate pipelines. The high pressure shrinkage rate is \$.00015 per therm, and the low pressure shrinkage rate is \$.00434 per therm. Additionally customers will pay the Southwest Gas Transmission Company (SGTC) Annual Charge Adjustment (ACA) rate of \$.00015 per therm for all scheduled volumes that flow through the SGTC pipeline. The ACA Charge will also apply to applicable traded and imbalance volumes. In addition, the customer will also pay a Transportation Service Charge of \$500.00 per month per individually qualifying premise. For purposes of calculating Payment for Excess Imbalances, the Imbalance Commodity Charge is \$1.17671 per therm and the Imbalance Reservation Charge is \$.03652 per therm. For customers converting from sales service, an additional amount equal to the currently effective Deferred Energy Accounting Adjustment will be assessed for a period of twelve (12) months.

3/ Includes the following:

Component/Schedule	SG-RS	SG-RM	SG-RAC	SG-G1	SG-G2	SG-G3	SG-G4	SG-G5
Margin	.61574	.60765	.15790	.39865	.14942	.13446	.06892	.01558
Accumulated Deferred Interest Rate Adjustment	.00878	.00878	.00878	.00878	.00878	.00878	.00878	.00878
General Revenues Adjustment	(.00597)	(.01694)	.00000	(.10370)	(.02596)	(.03168)	.02134	.00000
Gas Infrastructure Replacement Rate	.00000	.00000	.00000	.00000	.00000	.00000	.00000	.00000
Conservation and Energy Efficiency	.00252	.00252	.00252	.00252	.00252	.00252	.00252	.00252
Total	.62107	.60201	.16920	.30625	.13476	.11408	.10156	.02688

Component/Schedule	SG-G6	SG-AC	SG-WP	SG-EG	SG-CNG	SG-L
Margin	.03848	.13184	.11272	.07381	.14126	.62880
Accumulated Deferred Interest Rate Adjustment	.00878	.00878	.00878	.00878	.00878	.00878
General Revenues Adjustment	.00000	.00000	.00000	.00000	.00000	.00000
Gas Infrastructure Replacement Rate	.00000	.00000	.00000	.00000	.00000	.00000
Conservation and Energy Efficiency	.00252	.00252	.00252	.00252	.00252	.00252
Total	.04978	.14314	.12402	.08511	.15256	.64010

- 4/ For all rate schedules, the Base Tariff Energy Rate (BTER) includes \$.00996 per therm for the Unrecovered Gas Cost Expense Base Rate.
- 5/ The total monthly demand charge for Schedule Nos. SG-G4, SG-G5, and SG-G6 is equal to the unit rate shown multiplied by the customer's billing determinant.
- 6/ The charges for Schedule No. SG-CNG are subject to adjustments for applicable state and federal taxes on fuel used in motor vehicles.
- 7/ In addition to all other rates in this Statement of Rates, all customers in the Mesquite Expansion Area will pay a rate of \$.00340 per therm as part of their Infrastructure Expansion Rate.
- 8/ The maximum and minimum rates for Schedule Nos. SG-G5 and SG-G6 are set forth below.

SG-G5	Minimum Rates	Maximum Rates
Basic Service Charge	\$1,000.00	Effective tariff rates
Transportation Charge	\$500.00	
Demand Charge	\$0.00186	
Margin	\$0.00779	

SG-G6	Minimum Rates	Maximum Rates
Basic Service Charge	\$1,000.00	Effective tariff rates
Transportation Charge	\$500.00	
Demand Charge	\$0.01208	
Margin	\$0.01924	

<p>Issued:</p> <p align="center">May 3, 2024</p> <p>Effective:</p> <p align="center">May 1, 2024</p> <p>Advice Letter No.:</p>	<p>Issued by</p> <p>Amy L. Timperley Senior Vice President/ Chief Regulatory Strategy and Planning Officer</p>	
--	--	--

STATEMENT OF RATES
EFFECTIVE RATES APPLICABLE TO NORTHERN NEVADA SCHEDULES ^{1/2/8}

Schedule Number	Description	Delivery Charge ^{3/}	Gas Cost			Renewable Energy Program Rate	Infrastructure Expansion Rate ^{9/}	Currently Effective Tariff Rate
			Base Tariff Energy Rate ^{4/}	Deferred Energy Account Adjustment				
<u>NG-RS</u>	<u>Single-Family Residential Gas Service</u>							
	Basic Service Charge per Month	\$ 10.80						\$ 10.80
	Commodity Charge per Therm:							
	All Usage	\$.39062	\$ 1.11181	\$.25000	\$.00000	\$.01653		\$ 1.76896 R
<u>NG-RM</u>	<u>Multi-Family Residential Gas Service</u>							
	Basic Service Charge per Month	\$ 10.80						\$ 10.80
	Commodity Charge per Therm:							
	All Usage	\$.38915	\$ 1.11181	\$.25000	\$.00000	\$.01653		\$ 1.76749 R
<u>NG-RAC</u>	<u>Air Conditioning Residential Gas Service</u>							
	Basic Service Charge per Month	\$ 10.80						\$ 10.80
	Commodity Charge per Therm:							
	All Usage	\$.52050	\$ 1.11181	\$.25000	\$.00000	\$.01653		\$ 1.89884 I
<u>NG-G1</u>	<u>General Gas Service - 1</u>							
	Basic Service Charge per Month	\$ 28.80						\$ 28.80
	Commodity Charge per Therm:							
	All Usage	\$.24422	\$ 1.11181	\$.25000	\$.00000	\$.01653		\$ 1.62256 R
<u>NG-G2</u>	<u>General Gas Service - 2</u>							
	Basic Service Charge per Month	\$ 135.00						\$ 135.00
	Commodity Charge per Therm:							
	All Usage	\$.09819	\$ 1.11181	\$.25000	\$.00000	\$.01653		\$ 1.47653 R
<u>NG-G3</u>	<u>General Gas Service - 3</u>							
	Basic Service Charge per Month	\$ 350.00						\$ 350.00
	Commodity Charge per Therm:							
	All Usage	\$.11731	\$ 1.11181	\$.25000	\$.00000	\$.01653		\$ 1.49565 I
<u>NG-G4</u>	<u>General Gas Service - 4</u>							
	Basic Service Charge per Month	\$1,000.00						\$1,000.00
	Commodity Charge per Therm:							
	All Usage	\$.05935	\$ 1.11181	\$.25000	\$.00000	\$.01653		\$ 1.43769 I
	Demand Charge ^{5/}	\$.01588						\$.01588
<u>NG-G5</u>	<u>General Gas Service - 5 ^{7/}</u>							
	Basic Service Charge per Month	\$1,000.00						\$1,000.00
	Commodity Charge per Therm:							
	All Usage	\$.02678	\$ 1.11181	\$.25000	\$.00000	\$.01653		\$ 1.40512 I
	Demand Charge ^{5/}	\$.01833						\$.01833

<p>Issued:</p> <p align="center">May 3, 2024</p> <p>Effective:</p> <p align="center">May 1, 2024</p> <p>Advice Letter No.:</p>	<p>Issued by</p> <p>Amy L. Timperley</p> <p>Senior Vice President/ Chief Regulatory Strategy and Planning Officer</p>	
--	--	--

STATEMENT OF RATES
EFFECTIVE RATES APPLICABLE TO NORTHERN NEVADA SCHEDULES ^{1/2/8}

Schedule Number	Description	Delivery Charge ^{3/}	Gas Cost		Renewable Energy Program Rate	Infrastructure Expansion Rate ^{9/}	Currently Effective Tariff Rate
			Base Tariff Energy Rate ^{4/}	Deferred Energy Account Adjustment			
NG-AC	Air Conditioning Gas Service						
	Basic Service Charge per Month	\$ 28.80					\$ 28.80
	Commodity Charge per Therm:						
	All Usage	\$.12779	\$ 1.11181	\$.25000	\$.00000	\$.01653	\$ 1.50613
NG-WP	Water Pumping Gas Service						
	Basic Service Charge per Month	\$ 36.00					\$ 36.00
	Commodity Charge per Therm:						
	All Usage	\$.17147	\$ 1.11181	\$.25000	\$.00000	\$.01653	\$ 1.54981
NG-EG	Small Electric Generation Gas						
	Basic Service Charge per Month	Otherwise Applicable Rate Schedule					
	Commodity Charge per Therm:						
	All Usage	\$.07920	\$ 1.11181	\$.25000	\$.00000	\$.01653	\$ 1.45754
NG-CNG	Gas Service for Compression on Customer's Premises ^{6/}						
	Basic Service Charge	\$ 25.80					\$ 25.80
	Commodity Charge per Therm:						
	All Usage	\$1.22312	\$ 1.11181	\$.25000	\$.00000	\$.01653	\$ 2.60146
NG-L	Street and Outdoor Lighting Gas Service						
	Commodity Charge per Therm:						
	All Usage	\$.65968	\$ 1.11181	\$.25000	\$.00000	\$.01653	\$ 2.03802
NG-OS	Optional Gas Service						
		As specified on Sheet Nos. 48 through 51.					
NG-AS	Alternative Sales Service						
		As specified on Sheet Nos. 52 through 53.					
NG-CGS	Compression Gas Service						
		As specified on Sheet Nos. 47A through 47I					
NG-RNG	Biogas and Renewable Natural Gas Service						
		As specified on Sheet Nos. 53A through 53I					

<p>Issued: May 3, 2024</p> <p>Effective: May 1, 2024</p> <p>Advice Letter No.:</p>	<p>Issued by Amy L. Timperley Senior Vice President/ Chief Regulatory Strategy and Planning Officer</p>
--	---

STATEMENT OF RATES
EFFECTIVE RATES APPLICABLE TO NORTHERN NEVADA SCHEDULES ^{1/2/8}
(Continued)

- 1/ The charges shown above are subject to adjustments for taxes and assessments.
- 2/ Customers taking transportation service will pay the Basic Service Charge, the Delivery Charge per therm excluding the Conservation and Energy Efficiency component, and Demand Charge, if applicable, of the Currently Effective Tariff Rate for each meter included in the transportation service agreement, plus an amount of \$0.00345 per therm for distribution system shrinkage as defined in Rule No. 1 of this Nevada Gas Tariff for all volumes of gas not delivered through a direct connection to one of the Company's upstream interstate pipelines and a Transportation Service Charge of \$500.00 per month per individually qualifying premise. For purposes of calculating Payment for Excess Imbalances, the Imbalance Commodity Charge is \$1.14588 per therm and the Imbalance Reservation Charge is \$0.31699 per therm. For customers converting from sales service, an additional amount equal to the currently effective Deferred Energy Accounting Adjustment will be assessed for a period of twelve (12) months.
- 3/ Includes the following:

Component/Schedule	NG-RS	NG-RM	NG-RAC	NG-G1	NG-G2	NG-G3	NG-G4
Margin	.43618	.44199	.52154	.28094	.11385	.08689	.05788
General Revenues Adjustment	(.04452)	(.05180)	.00000	(.03568)	(.01462)	.03146	.00251
Gas Infrastructure Replacement Rate	.00000	.00000	.00000	.00000	.00000	.00000	.00000
Conservation and Energy Efficiency	(.00104)	(.00104)	(.00104)	(.00104)	(.00104)	(.00104)	(.00104)
Total	.39062	.38915	.52050	.24422	.09819	.11731	.05935

Component/Schedule	NG-G5	NG-AC	NG-WP	NG-EG	NG-CNG	NG-L
Margin	.02782	.12883	.17251	.08024	1.22416	.66072
General Revenues Adjustment	.00000	.00000	.00000	.00000	.00000	.00000
Gas Infrastructure Replacement Rate	.00000	.00000	.00000	.00000	.00000	.00000
Conservation and Energy Efficiency	(.00104)	(.00104)	(.00104)	(.00104)	(.00104)	(.00104)
Total	.02678	.12779	.17147	.07920	1.22312	.65968

- 4/ For all rate schedules, the Base Tariff Energy Rate (BTER) includes \$0.00877 per therm for the Unrecovered Gas Cost Expense Base Rate.
- 5/ The total monthly demand charge for Schedule Nos. NG-G4 and NG-G5 is equal to the unit rate shown multiplied by the customer's billing determinant.
- 6/ The charges for Schedule No. NG-CNG are subject to adjustments for applicable state and federal taxes on fuel used in motor vehicles.
- 7/ The maximum and minimum rates for Schedule No. NG-G5 are set forth below.

NG-G5	Minimum Rates	Maximum Rates
Basic Service Charge	\$1,000.00	Effective tariff rates
Transportation Charge	\$500.00	
Demand Charge	\$0.00917	
Margin	\$0.01391	

<p>Issued: May 3, 2024</p> <p>Effective: May 1, 2024</p> <p>Advice Letter No.:</p>	<p>Issued by Amy L. Timperley Senior Vice President/ Chief Regulatory Strategy and Planning Officer</p>
--	---

STATEMENT OF RATES
EFFECTIVE RATES APPLICABLE TO NORTHERN NEVADA SCHEDULES ^{1/2/8/}
(Continued)

8/ In addition to all other rates in this Statement of Rates, customers located in the Spring Creek Expansion Area will pay a monthly per meter Infrastructure Expansion Charge as follows:

Component/Schedule	NG-RS	NG-RM	NG-RAC	NG-G1	NG-G2	NG-G3
Infrastructure Expansion Charge	35.00	35.00	NA	35.00	70.00	70.00

Component/Schedule	NG-G4	NG-AC	NG-WP	NG-EG	NG-CNG	NG-L
Infrastructure Expansion Charge	70.00	NA	NA	NA	NA	NA

9/ In addition to all other rates in this Statement of Rates, customers located in the Elko District, as described as Parcel 3 on Sheet No. 112A, will pay the Elko District rates set forth below as part of their Infrastructure Expansion Rate. Customers in the Spring Creek Expansion Area, as described as Parcel 3A on Sheet Nos. 112A through 112B, will pay both the Elko District and Spring Creek Expansion Area Rates set forth below as part of their Infrastructure Expansion Rate.

Area/Schedule	NG-RS, NG-RM, NG-RAC, NG-G1, NG-G2, NG-G3, NG-AC, NG-WP, NG-EG, NG-CNG, NG-L	NG-G4
Elko District	.03500	.02000
Spring Creek Expansion Area	.02550	.02550

<p>Issued: May 31, 2022</p> <p>Effective: July 1, 2022</p> <p>Advice Letter No.: 530</p>	<p>Issued by Amy L. Timperley Senior Vice President/ Chief Regulatory Officer</p>	
--	--	--

STATEMENT OF RATES
EFFECTIVE RATES APPLICABLE TO NORTHERN NEVADA SCHEDULES ^{1/2/8/}
(Continued)

8/ In addition to all other rates in this Statement of Rates, customers located in the Spring Creek Expansion Area will pay a monthly per meter Infrastructure Expansion Charge as follows:

Component/Schedule	NG-RS	NG-RM	NG-RAC	NG-G1	NG-G2	NG-G3
Infrastructure Expansion Charge	35.00	35.00	NA	35.00	70.00	70.00

Component/Schedule	NG-G4	NG-AC	NG-WP	NG-EG	NG-CNG	NG-L
Infrastructure Expansion Charge	70.00	NA	NA	NA	NA	NA

9/ In addition to all other rates in this Statement of Rates, customers located in the Elko District, as described as Parcel 3 on Sheet No. 112A, will pay the Elko District rates set forth below as part of their Infrastructure Expansion Rate. Customers in the Spring Creek Expansion Area, as described as Parcel 3A on Sheet Nos. 112A through 112B, will pay both the Elko District and Spring Creek Expansion Area Rates set forth below as part of their Infrastructure Expansion Rate.

Area/Schedule	NG-RS, NG-RM, NG-RAC, NG-G1, NG-G2, NG-G3, NG-AC, NG-WP, NG-EG, NG-CNG, NG-L	NG-G4
Elko District	.03500	.02000
Spring Creek Expansion Area	.02550	.02550

<p>Issued: May 31, 2022</p> <p>Effective: July 1, 2022</p> <p>Advice Letter No.: 530</p>	<p>Issued by Amy L. Timperley Senior Vice President/ Chief Regulatory Officer</p>	
--	--	--

**STATEMENT OF RATES
OTHER SERVICE CHARGES**

Description	Southern Nevada	Northern Nevada
<u>Service Establishment Charge</u> ^{1/}		
Normal Service	\$ 25.00	\$ 25.00
Expedited Service	40.00	40.00
<u>Customer-Requested Meter Tests</u>		
First Test	\$ 0.00	\$ 0.00
Subsequent Tests ^{2/}	7.50	7.50
<u>Returned Item Charge</u>		
Per Item	\$ 10.00	\$ 10.00
<u>Transaction Fees</u>		
Credit Card Payments ^{3/}		
Residential Customers	\$ 2.50	\$ 2.50
Commercial Customers	1.5% of transaction	1.5% of transaction
Paystation Payments ^{4/}	1.50	1.50
<u>Street and Outdoor Lighting</u>		
<u>Permanent Disconnection Fee</u> ^{5/}		
Per Device	\$ 60.00	\$ 60.00
<u>Excess Flow Valve Installation</u>		
Per Installation	\$ 200.00	\$ 200.00

^{1/} Subject to adjustment for any taxes or governmental impositions.

^{2/} For customers whose annual usage exceeds 180,000 therms per year, the Company may, at its sole discretion, charge the customer for any costs actually incurred by the Company in performing the meter test.

^{3/} A transaction fee is assessed and paid directly to the third-party vendor for transactions processed using a credit or debit card. For Residential Customers, a transaction fee of \$2.50 will be assessed for amounts up to \$750.00. For Commercial Customers, a transaction fee of 1.5% of the total transaction will be assessed and there is no dollar limit for that transaction. For purposes of this section, a Residential Customer is defined as any customer served under the SG-RS, NG-RS, SG-RM, NG-RM, SG-RAC or NG-RAC rate schedules. A Commercial Customer is any customer not served under a Company rate schedule that is considered a Residential Customer pursuant to this tariff section.

^{4/} A transaction fee is assessed and paid directly to the third-party vendor for payment processed at a Paystation location.

^{5/} Applicable to lighting devices served under Schedule No. SG-L/NG-L when the customer has requested permanent disconnection from the Company's distribution system.

<p>Issued: February 17, 2021</p> <p>Effective: May 1, 2021</p> <p>Advice Letter No.: 522</p>	<p>Issued by Justin Lee Brown Senior Vice President</p>	
--	---	--

SCHEDULE NO. SG-RS/NG-RS

SINGLE-FAMILY RESIDENTIAL GAS SERVICE

APPLICABILITY

Applicable to customers receiving gas service in a single-family residential structure.

TERRITORY

Throughout the Company's certificated Nevada Service Areas, except as may hereafter be provided.

RATES

The commodity charge and Basic Service Charge are set forth in the currently effective Statement of Rates of this Nevada Gas Tariff and are incorporated herein by reference.

The minimum charge per month is the Basic Service Charge, as applicable.

LATE CHARGE

The monthly bill is due and payable as of the date of presentation. Included in the bill will be a late charge of five percent on the first \$200 of the monthly bill, plus two percent of any balance above \$200, which will be imposed if payment is not received by the next month's billing.

BASE TARIFF ENERGY RATE (BTER) AND DEFERRED ENERGY ACCOUNT ADJUSTMENT (DEAA)

The rates specified for this schedule are subject to increases or decreases in the cost of purchased gas in accordance with those provisions set forth in Chapter 704 of the NAC.

GENERAL TERMS AND CONDITIONS

Except as qualified in this schedule, all of the General Terms and Conditions are applicable to this schedule and are hereby made a part hereof.

<p>Issued: December 31, 2018</p> <p>Effective: January 1, 2019</p> <p>Advice Letter No.:</p>	<p>Issued by Justin Lee Brown Senior Vice President</p>	
--	---	--

SCHEDULE NO. SG-RM/NG-RM
MULTI-FAMILY RESIDENTIAL GAS SERVICE

APPLICABILITY

Applicable to customers receiving gas service in a multi-family residential structure.

TERRITORY

Throughout the Company's certificated Nevada Service Areas, except as may hereafter be provided.

RATES

The commodity charge and Basic Service Charge are set forth in the currently effective Statement of Rates of this Nevada Gas Tariff and are incorporated herein by reference.

The minimum charge per month is the Basic Service Charge, as applicable.

LATE CHARGE

The monthly bill is due and payable as of the date of presentation. Included in the bill will be a late charge of five percent on the first \$200 of the monthly bill, plus two percent of any balance above \$200, which will be imposed if payment is not received by the next month's billing.

BASE TARIFF ENERGY RATE (BTER) AND DEFERRED ENERGY ACCOUNT ADJUSTMENT (DEAA)

The rates specified for this schedule are subject to increases or decreases in the cost of purchased gas in accordance with those provisions set forth in Chapter 704 of the NAC.

GENERAL TERMS AND CONDITIONS

Except as qualified in this schedule, all of the General Terms and Conditions are applicable to this schedule and are hereby made a part hereof.

<p>Issued: December 31, 2018</p> <p>Effective: January 1, 2019</p> <p>Advice Letter No.:</p>	<p style="text-align: center;">Issued by Justin Lee Brown Senior Vice President</p>	
--	---	--

SOUTHWEST GAS CORPORATION
P.O. Box 98510
Las Vegas, Nevada 89193-8510
Nevada Gas Tariff No. 7

Canceling 2nd Revised P.U.C.N. Sheet No. 18
1st Revised P.U.C.N. Sheet No. 18

HELD FOR FUTURE USE

T/L

Issued:
December 31, 2018

Effective:
January 1, 2019

Advice Letter No.:

Issued by
Justin Lee Brown
Senior Vice President

T

SCHEDULE NO. SG-RAC/NG-RAC

AIR CONDITIONING RESIDENTIAL GAS SERVICE

APPLICABILITY

Applicable to all gas service to residential customers with natural gas air conditioning equipment which meets the Company's specifications and approval. Customer eligibility is subject to verification of installed gas air conditioning equipment.

TERRITORY

Throughout the Company's certificated Nevada Service Areas, except as may hereafter be provided.

RATES

The commodity charge and Basic Service Charge are set forth in the currently effective Statement of Rates of this Nevada Gas Tariff and are incorporated herein by reference.

The minimum charge per month is the Basic Service Charge, as applicable.

LATE CHARGE

The monthly bill is due and payable as of the date of presentation. Included in the bill will be a late charge of five percent on the first \$200 of the monthly bill, plus two percent of any balance above \$200, which will be imposed if payment is not received by the next month's billing.

BASE TARIFF ENERGY RATE (BTER) AND DEFERRED ENERGY ACCOUNT
ADJUSTMENT (DEAA)

The rates specified for this schedule are subject to increases or decreases in the cost of purchased gas in accordance with those provisions set forth in Chapter 704 of the NAC.

<p>Issued: December 31, 2018</p> <p>Effective: January 1, 2019</p> <p>Advice Letter No.:</p>	<p>Issued by Justin Lee Brown Senior Vice President</p>	
--	---	--

SCHEDULE NO. SG-RAC/NG-RAC

AIR CONDITIONING RESIDENTIAL GAS SERVICE
(Continued)

GENERAL TERMS AND CONDITIONS

Except as qualified in this schedule, all of the General Terms and Conditions are applicable to this schedule and are hereby made a part hereof.

Issued:
December 5, 2012

Effective:
January 1, 2013

Advice Letter No.:

Issued by
John P. Hester
Senior Vice President

SCHEDULE NO. SG-G1/NG-G1

GENERAL GAS SERVICE - 1

APPLICABILITY

Applicable to commercial, industrial, electric generation and master meter customers as defined in Rule No. 1 of this Nevada Gas Tariff whose average monthly requirements on an annual basis are less than or equal to 600 therms. This schedule is closed for new Master Meter Mobile Home Park Gas Service.

TERRITORY

Throughout the Company's certificated Nevada Service Areas, except as may hereafter be provided.

RATES

The commodity charge and Basic Service Charge are set forth in the currently effective Statement of Rates of this Nevada Gas Tariff and are incorporated herein by reference.

For transportation customers electing to switch to sales service under this schedule, the Base Tariff Energy Rate (BTER) of the customer's sales rate will be determined in accordance with Special Condition No. 4 of this schedule.

The minimum charge per month is the Basic Service Charge.

LATE CHARGE

The monthly bill is due and payable as of the date of presentation. Included in the bill will be a late charge of five percent on the first \$200 of the monthly bill, plus two percent of any balance above \$200, which will be imposed if payment is not received by the next month's billing.

<p>Issued: December 31, 2018</p> <p>Effective: January 1, 2019</p> <p>Advice Letter No.:</p>	<p>Issued by Justin Lee Brown Senior Vice President</p>	
--	---	--

SCHEDULE NO. SG-G1/NG-G1

GENERAL GAS SERVICE - 1

(Continued)

SPECIAL CONDITIONS

1. A service agreement specifying the customer's volumetric requirements and curtailment priority as defined in NAC 704.501 may be required under this schedule.
2. To initiate service under this schedule, customers who presently take transportation or alternative sales service under Schedule Nos. ST-1/NT-1 or SG-AS/NG-AS must make a three-year commitment to sales service.
3. Customers under this schedule may elect transportation service after providing an 18 month notification; however, customers with an active sales service agreement can return to transportation service only at the conclusion of their sales service agreement after providing at least 18 months notice.

Customers who switch to transportation service without providing proper notice will be assessed an exit fee to prevent the shifting of any costs to its remaining sales customers, if the Company determines there are such costs associated with the customer's change in service.

4. Upon switching from transportation service to sales service under this schedule, the Base Tariff Energy Rate (BTER) of the customer's sales rate will be the higher of the following charges for the initial 12 month sales period:
 - (i) The BTER of the Currently Effective Tariff Rate; or
 - (ii) The monthly weighted average cost of gas, including an assessment for interstate capacity costs, incurred by the Company.

<p>Issued: December 31, 2018</p> <p>Effective: January 1, 2019</p> <p>Advice Letter No.:</p>	<p>Issued by Justin Lee Brown Senior Vice President</p>	
--	---	--

SCHEDULE NO. SG-G1/NG-G1

GENERAL GAS SERVICE - 1

(Continued)

SPECIAL CONDITIONS *(Continued)*

The customer's sales rate will be adjusted to exclude the Deferred Energy Account Adjustment (DEAA) for the initial 12 month sales period. After the conclusion of the initial twelve 12 month sales period, the customer shall be billed at the Currently Effective Tariff Rate.

5. The Company is not responsible for the condition and repair of gas distribution lines, equipment, or any other facilities on the customer's side of a mobile home park master meter.

BASE TARIFF ENERGY RATE (BTER) AND DEFERRED ENERGY ACCOUNT ADJUSTMENT (DEAA)

The rates specified for this schedule are subject to increases or decreases in the cost of purchased gas in accordance with those provisions set forth in Chapter 704 of the NAC.

GENERAL TERMS AND CONDITIONS

Except as qualified in this schedule, all of the General Terms and Conditions are applicable to this schedule and are hereby made a part hereof.

<p>Issued: December 31, 2018</p> <p>Effective: January 1, 2019</p> <p>Advice Letter No.:</p>	<p>Issued by Justin Lee Brown Senior Vice President</p>	
--	---	--

SCHEDULE NO. SG-G2/NG-G2

GENERAL GAS SERVICE - 2

APPLICABILITY

Applicable to commercial, industrial, electric generation and master meter customers as defined in Rule No. 1 of this Nevada Gas Tariff whose average monthly requirements on an annual basis are greater than 600 therms, but less than or equal to 4,167 therms. This schedule is closed for new Master Meter Mobile Home Park Gas Service.

TERRITORY

Throughout the Company's certificated Nevada Service Areas, except as may hereafter be provided.

RATES

The commodity charge and Basic Service Charge are set forth in the currently effective Statement of Rates of this Nevada Gas Tariff and are incorporated herein by reference.

For transportation customers electing to switch to sales service under this schedule, the Base Tariff Energy Rate (BTER) of the customer's sales rate will be determined in accordance with Special Condition No. 4 of this schedule.

The minimum charge per month is the Basic Service Charge.

LATE CHARGE

The monthly bill is due and payable as of the date of presentation. Included in the bill will be a late charge of five percent on the first \$200 of the monthly bill, plus two percent of any balance above \$200, which will be imposed if payment is not received by the next month's billing.

<p>Issued: December 31, 2018</p> <p>Effective: January 1, 2019</p> <p>Advice Letter No.:</p>	<p>Issued by Justin Lee Brown Senior Vice President</p>	
--	---	--

SCHEDULE NO. SG-G2/NG-G2

GENERAL GAS SERVICE - 2

(Continued)

SPECIAL CONDITIONS

1. A service agreement specifying the customer's volumetric requirements and curtailment priority as defined in NAC 704.501 may be required under this schedule.
2. To initiate service under this schedule, customers who presently take transportation or alternative sales service under Schedule Nos. ST-1/NT-1 or SG-AS/NG-AS must make a three-year commitment to sales service.
3. Customers under this schedule may elect transportation service after providing an 18 month notification; however, customers with an active sales service agreement can return to transportation service only at the conclusion of their sales service agreement after providing at least 18 months notice.

Customers who switch to transportation service without providing proper notice will be assessed an exit fee to prevent the shifting of any costs to its remaining sales customers, if the Company determines there are such costs associated with the customer's change in service.

4. Upon switching from transportation service to sales service under this schedule, the Base Tariff Energy Rate (BTER) of the customer's sales rate will be the higher of the following charges for the initial 12 month sales period:
 - (i) The BTER of the Currently Effective Tariff Rate; or
 - (ii) The monthly weighted average cost of gas, including an assessment for interstate capacity costs, incurred by the Company.

<p>Issued: December 31, 2018</p> <p>Effective: January 1, 2019</p> <p>Advice Letter No.:</p>	<p>Issued by Justin Lee Brown Senior Vice President</p>	
--	---	--

SCHEDULE NO. SG-G2/NG-G2

GENERAL GAS SERVICE - 2

(Continued)

SPECIAL CONDITIONS *(Continued)*

The customer's sales rate will be adjusted to exclude the Deferred Energy Account Adjustment (DEAA) for the initial 12 month sales period. After the conclusion of the initial 12 month sales period, the customer shall be billed at the Currently Effective Tariff Rate.

5. The Company is not responsible for the condition and repair of gas distribution lines, equipment, or any other facilities on the customer's side of a mobile home park master meter.

BASE TARIFF ENERGY RATE (BTER) AND DEFERRED ENERGY ACCOUNT ADJUSTMENT (DEAA)

The rates specified for this schedule are subject to increases or decreases in the cost of purchased gas in accordance with those provisions set forth in Chapter 704 of the NAC.

GENERAL TERMS AND CONDITIONS

Except as qualified in this schedule, all of the General Terms and Conditions are applicable to this schedule and are hereby made a part hereof.

Issued:
December 31, 2018

Effective:
January 1, 2019

Advice Letter No.:

Issued by
Justin Lee Brown
Senior Vice President

SCHEDULE NO. SG-G3/NG-G3

GENERAL GAS SERVICE - 3

APPLICABILITY

Applicable to commercial, industrial, electric generation and master meter customers as defined in Rule No. 1 of this Nevada Gas Tariff whose average monthly requirements on an annual basis are greater than 4,167 therms, but less than or equal to 15,000 therms. This schedule is closed for new Master Meter Mobile Home Park Gas Service.

TERRITORY

Throughout the Company's certificated Nevada Service Areas, except as may hereafter be provided.

RATES

The commodity charge and Basic Service Charge are set forth in the currently effective Statement of Rates of this Nevada Gas Tariff and are incorporated herein by reference.

For transportation customers electing to switch to sales service under this schedule, the Base Tariff Energy Rate (BTER) of the customer's sales rate will be determined in accordance with Special Condition No. 4 of this schedule.

The minimum charge per month is the Basic Service Charge.

LATE CHARGE

The monthly bill is due and payable as of the date of presentation. Included in the bill will be a late charge of five percent on the first \$200 of the monthly bill, plus two percent of any balance above \$200, which will be imposed if payment is not received by the next month's billing.

<p>Issued: December 31, 2018</p> <p>Effective: January 1, 2019</p> <p>Advice Letter No.:</p>	<p>Issued by Justin Lee Brown Senior Vice President</p>	
--	---	--

SCHEDULE NO. SG-G3/NG-G3

GENERAL GAS SERVICE - 3

(Continued)

SPECIAL CONDITIONS

1. A service agreement specifying the customer's volumetric requirements and curtailment priority as defined in NAC 704.501 may be required under this schedule.
2. To initiate service under this schedule, customers who presently take transportation or alternative sales service under Schedule Nos. ST-1/NT-1 or SG-AS/NG-AS must make a three-year commitment to sales service.
3. Customers under this schedule may elect transportation service after providing an 18 month notification; however, customers with an active sales service agreement can return to transportation service only at the conclusion of their sales service agreement after providing at least 18 months notice.

Customers who switch to transportation service without providing proper notice will be assessed an exit fee to prevent the shifting of any costs to its remaining sales customers, if the Company determines there are such costs associated with the customer's change in service.

4. Upon switching from transportation service to sales service under this schedule, the Base Tariff Energy Rate (BTER) of the customer's sales rate will be the higher of the following charges for the initial 12 month sales period:
 - (i) The BTER of the Currently Effective Tariff Rate; or
 - (ii) The monthly weighted average cost of gas, including an assessment for interstate capacity costs, incurred by the Company.

<p>Issued: December 31, 2018</p> <p>Effective: January 1, 2019</p> <p>Advice Letter No.:</p>	<p>Issued by Justin Lee Brown Senior Vice President</p>	
--	---	--

SCHEDULE NO. SG-G3/NG-G3

GENERAL GAS SERVICE - 3

(Continued)

SPECIAL CONDITIONS *(Continued)*

The customer's sales rate will be adjusted to exclude the Deferred Energy Account Adjustment (DEAA) for the initial 12 month sales period. After the conclusion of the initial 12 month sales period, the customer shall be billed at the Currently Effective Tariff Rate.

5. The Company is not responsible for the condition and repair of gas distribution lines, equipment, or any other facilities on the customer's side of a mobile home park master meter.

BASE TARIFF ENERGY RATE (BTER) AND DEFERRED ENERGY ACCOUNT ADJUSTMENT (DEAA)

The rates specified for this schedule are subject to increases or decreases in the cost of purchased gas in accordance with those provisions set forth in Chapter 704 of the NAC.

GENERAL TERMS AND CONDITIONS

Except as qualified in this schedule, all of the General Terms and Conditions are applicable to this schedule and are hereby made a part hereof.

<p>Issued: December 31, 2018</p> <p>Effective: January 1, 2019</p> <p>Advice Letter No.:</p>	<p>Issued by Justin Lee Brown Senior Vice President</p>	
--	---	--

SCHEDULE NO. SG-G4/NG-G4

GENERAL GAS SERVICE - 4

APPLICABILITY

Applicable to commercial, industrial, electric generation and master meter customers as defined in Rule No. 1 of this Nevada Gas Tariff whose average monthly requirements on an annual basis are greater than 15,000 therms. This schedule is closed for new Master Meter Mobile Home Park Gas Service.

TERRITORY

Throughout the Company's certificated Nevada Service Areas, except as may hereafter be provided.

RATES

The demand charge, commodity charge and Basic Service Charge are set forth in the currently effective Statement of Rates of this Nevada Gas Tariff and are incorporated herein by reference.

For transportation customers electing to switch to sales service under this schedule, the Base Tariff Energy Rate (BTER) of the customer's sales rate will be determined in accordance with Special Condition No. 4 of this schedule.

The monthly demand charge shall be the product of the demand charge rate multiplied by the customer's billing determinant. The billing determinant shall be equal to the customer's highest monthly throughput during the most recent 12 month period, ending the month prior to the current billing period. For new customers, the initial billing determinant shall be calculated by multiplying the customer's estimated average daily use by the number of days in the billing period.

The minimum charge per month is the sum of the Basic Service Charge and the demand charge.

<p>Issued: December 31, 2018</p> <p>Effective: January 1, 2019</p> <p>Advice Letter No.:</p>	<p>Issued by Justin Lee Brown Senior Vice President</p>	
--	---	--

SCHEDULE NO. SG-G4/NG-G4

GENERAL GAS SERVICE - 4

(Continued)

LATE CHARGE

The monthly bill is due and payable as of the date of presentation. Included in the bill will be a late charge of five percent on the first \$200 of the monthly bill, plus two percent of any balance above \$200, which will be imposed if payment is not received by the next month's billing.

SPECIAL CONDITIONS

1. A service agreement specifying the customer's volumetric requirements and curtailment priority as defined in NAC 704.501 may be required under this schedule.
2. To initiate service under this schedule, customers who presently take transportation or alternative sales service under Schedule Nos. ST-1/NT-1 or SG-AS/NG-AS must make a three-year commitment to sales service.
3. Customers under this schedule may elect transportation service after providing an 18 month notification; however, customers with an active sales service agreement can return to transportation service only at the conclusion of their sales service agreement after providing at least 18 months notice.

Customers who switch to transportation service without providing proper notice will be assessed an exit fee to prevent the shifting of any costs to its remaining sales customers, if the Company determines there are such costs associated with the customer's change in service.

<p>Issued: December 31, 2018</p> <p>Effective: January 1, 2019</p> <p>Advice Letter No.:</p>	<p>Issued by Justin Lee Brown Senior Vice President</p>	
--	---	--

SCHEDULE NO. SG-G4/NG-G4

GENERAL GAS SERVICE - 4

(Continued)

SPECIAL CONDITIONS *(Continued)*

4. Upon switching from transportation service to sales service under this schedule, the Base Tariff Energy Rate (BTER) of the customer's sales rate will be the higher of the following charges for the initial twelve 12 month sales period:

- (i) The BTER of the Currently Effective Tariff Rate; or
- (ii) The monthly weighted average cost of gas, including an assessment for interstate capacity costs, incurred by the Company.

The customer's sales rate will be adjusted to exclude the Deferred Energy Account Adjustment (DEAA) for the initial 12 month sales period. After the conclusion of the initial twelve 12 month sales period, the customer shall be billed at the Currently Effective Tariff Rate.

5. The Company is not responsible for the condition and repair of gas distribution lines, equipment, or any other facilities on the customer's side of a mobile home park master meter.

BASE TARIFF ENERGY RATE (BTER) AND DEFERRED ENERGY ACCOUNT ADJUSTMENT (DEAA)

The rates specified for this schedule are subject to increases or decreases in the cost of purchased gas in accordance with those provisions set forth in Chapter 704 of the NAC.

GENERAL TERMS AND CONDITIONS

Except as qualified in this schedule, all of the General Terms and Conditions are applicable to this schedule and are hereby made a part hereof.

<p>Issued: December 31, 2018</p> <p>Effective: January 1, 2019</p> <p>Advice Letter No.:</p>	<p>Issued by Justin Lee Brown Senior Vice President</p>	
--	---	--

SCHEDULE NO. SG-AC/NG-AC
AIR CONDITIONING GAS SERVICE

APPLICABILITY

Applicable to gas service to customers who have installed and regularly operate a gas-fired air conditioning system which meets the Company's specifications and approval.

The quantity of gas used for air conditioning purposes shall be determined by metering equipment installed by the Company, unless, by mutual agreement between customer and the Company, estimated gas quantities are used.

Service for any use other than for the installed gas-fired air conditioning system is prohibited under this schedule. All other use at the customer's premises will be charged at the otherwise applicable rate.

TERRITORY

Throughout the Company's certificated Nevada Service Areas, except as may hereafter be provided.

RATES

The commodity charge and the Basic Service Charge are set forth in the currently effective Statement of Rates of this Nevada Gas Tariff and are incorporated herein by reference.

For transportation customers electing to switch to sales service under this schedule, the Base Tariff Energy Rate (BTER) of the customer's sales rate will be determined in accordance with Special Condition No. 5 of this schedule.

The minimum charge per month is the Basic Service Charge.

<p>Issued: December 31, 2018</p> <p>Effective: January 1, 2019</p> <p>Advice Letter No.:</p>	<p>Issued by Justin Lee Brown Senior Vice President</p>	
--	---	--

SCHEDULE NO. SG-AC/NG-AC
AIR CONDITIONING GAS SERVICE
(Continued)

LATE CHARGE

The monthly bill is due and payable as of the date of presentation. Included in the bill will be a late charge of five percent on the first \$200 of the monthly bill, plus two percent of any balance above \$200, which will be imposed if payment is not received by the next month's billing.

SPECIAL CONDITIONS

1. If the customer is receiving service under this schedule in combination with another schedule, the Company, at its sole discretion may elect to charge the customer only one Basic Service Charge.
2. To initiate service under this schedule, customers who presently take transportation or alternative sales service under Schedule Nos. ST-1/NT-1 or SG-AS/NG-AS must make a three-year commitment to sales service.
3. Customers under this schedule may elect transportation service after providing an 18 month notification; however, customers with an active sales service agreement can return to transportation service only at the conclusion of their sales service agreement after providing at least eighteen 18 months notice.

Customers who switch to transportation service without providing proper notice will be assessed an exit fee to prevent the shifting of any costs to its remaining sales customers, if the Company determines there are such costs associated with the customer's change in service.

4. Gas service under this schedule is not available for "standby" or occasional temporary service.

<p>Issued: December 31, 2018</p> <p>Effective: January 1, 2019</p> <p>Advice Letter No.:</p>	<p>Issued by Justin Lee Brown Senior Vice President</p>	
--	---	--

SCHEDULE NO. SG-AC/NG-AC
AIR CONDITIONING GAS SERVICE
(Continued)

SPECIAL CONDITIONS (Continued)

5. Upon switching from transportation service to sales service under this schedule, the Base Tariff Energy Rate (BTER) of the customer's sales rate will be the higher of the following charges for the initial 12 month sales period:

- (i) The BTER of the Currently Effective Tariff Rate; or
- (ii) The monthly weighted average cost of gas, including an assessment for interstate capacity costs, incurred by the Company.

The customer's sales rate will be adjusted to exclude the Deferred Energy Account Adjustment (DEAA) for the initial 12 month sales period. After the conclusion of the initial 12 month sales period, the customer shall be billed at the Currently Effective Tariff Rate.

BASE TARIFF ENERGY RATE (BTER) AND DEFERRED ENERGY ACCOUNT
ADJUSTMENT (DEAA)

The rates specified for this schedule are subject to increases or decreases in the cost of purchased gas in accordance with those provisions set forth in Chapter 704 of the NAC.

GENERAL TERMS AND CONDITIONS

Except as qualified in this schedule, all of the General Terms and Conditions are applicable to this schedule and are hereby made a part hereof.

<p>Issued: December 31, 2018</p> <p>Effective: January 1, 2019</p> <p>Advice Letter No.:</p>	<p>Issued by Justin Lee Brown Senior Vice President</p>	
--	---	--

SCHEDULE NO. SG-WP/NG-WP

WATER PUMPING GAS SERVICE

APPLICABILITY

Applicable to gas service to agricultural irrigation pumping customers, domestic pumping customers and water companies for use as fuel in internal combustion engines for pumping water for agricultural irrigations uses, domestic uses or municipal uses.

TERRITORY

Throughout the Company's certificated Nevada Service Areas, except as may hereafter be provided.

RATES

The commodity charge and Basic Service Charge are set forth in the currently effective Statement of Rates of this Nevada Gas Tariff and are incorporated herein by reference.

For transportation customers electing to switch to sales service under this schedule, the Base Tariff Energy Rate (BTER) of the customer's sales rate will be determined in accordance with Special Condition No. 5 of this schedule.

The minimum charge per month is the Basic Service Charge.

LATE CHARGE

The monthly bill is due and payable as of the date of presentation. Included in the bill will be a late charge of five percent on the first \$200 of the monthly bill, plus two percent of any balance above \$200, which will be imposed if payment is not received by the next month's billing.

<p>Issued: December 31, 2018</p> <p>Effective: January 1, 2019</p> <p>Advice Letter No.:</p>	<p>Issued by Justin Lee Brown Senior Vice President</p>	
--	---	--

SCHEDULE NO. SG-WP/NG-WP

WATER PUMPING GAS SERVICE
(Continued)

SPECIAL CONDITIONS

1. All gas shall be supplied at a single point of delivery and measured through one meter. No other equipment may be supplied through this meter.
2. A service agreement shall be required under this schedule and shall contain the volumetric entitlement by curtailment priority as defined in NAC 704.501.
3. To initiate service under this schedule, customers who presently take transportation or alternative sales service under Schedule Nos. ST-1/NT-1 or SG-AS/NG-AS must make a three-year commitment to sales service.
4. Customers under this schedule may elect transportation service after providing an 18 month notification; however, customers with an active sales service agreement can return to transportation service only at the conclusion of their sales service agreement after providing at least 18 months notice.

Customers who switch to transportation service without providing proper notice will be assessed an exit fee to prevent the shifting of any costs to its remaining sales customers, if the Company determines there are such costs associated with the customer's change in service.

5. Upon switching from transportation service to sales service under this schedule, the Base Tariff Energy Rate (BTER) of the customer's sales rate will be the higher of the following charges for the initial 12 month sales period:
 - (i) The BTER of the Currently Effective Tariff Rate; or
 - (ii) The monthly weighted average cost of gas, including an assessment for interstate capacity costs, incurred by the Company.

<p>Issued: December 31, 2018</p> <p>Effective: January 1, 2019</p> <p>Advice Letter No.:</p>	<p>Issued by Justin Lee Brown Senior Vice President</p>	
--	---	--

SCHEDULE NO. SG-WP/NG-WP

WATER PUMPING GAS SERVICE
(Continued)

SPECIAL CONDITIONS (continued)

The customer's sales rate will be adjusted to exclude the Deferred Energy Account Adjustment (DEAA) for the initial 12 month sales period. After the conclusion of the initial 12 month sales period, the customer shall be billed at the Currently Effective Tariff Rate

BASE TARIFF ENERGY RATE (BTER) AND DEFERRED ENERGY ACCOUNT ADJUSTMENT (DEAA)

The rates specified for this schedule are subject to increases or decreases in the cost of purchased gas in accordance with those provisions set forth in Chapter 704 of the NAC.

GENERAL TERMS AND CONDITIONS

Except as qualified in this schedule, all of the General Terms and Conditions are applicable to this schedule and are hereby made a part hereof.

<p>Issued: December 31, 2018</p> <p>Effective: January 1, 2019</p> <p>Advice Letter No.:</p>	<p>Issued by Justin Lee Brown Senior Vice President</p>	
--	---	--

SCHEDULE NO. SG-EG/NG-EG

SMALL ELECTRIC GENERATION GAS SERVICE

APPLICABILITY

Applicable to gas service to customers who have installed and regularly operate gas-fired electric generation equipment whose average monthly requirements on an annual basis are less than 1,000,000 therms. The volume of gas used for electric generation purposes shall be determined by metering equipment installed by the Company.

TERRITORY

Throughout the Company's certificated area of the Nevada Service Areas, except as may hereafter be provided.

RATES

The Basic Service Charge is the charge under the customer's otherwise applicable gas sales tariff schedule. The commodity charge and the Basic Service Charge are set forth in the currently effective Statement of Rates of this Nevada Gas Tariff and are incorporated herein by reference.

For transportation customers electing to switch to sales service under this schedule, the Base Tariff Energy Rate (BTER) of the customer's sales rate will be determined in accordance with Special Condition No. 4 of this schedule.

The minimum charge per month is the Basic Service Charge.

LATE CHARGE

The monthly bill is due and payable as of the date of presentation. Included in the bill will be a late charge of five percent on the first \$200 of the monthly bill, plus two percent of any balance above \$200, which will be imposed if payment is not received by the next month's billing.

<p>Issued: April 28, 2023</p> <p>Effective: July 11, 2023</p> <p>Advice Letter No.: AL 534</p>	<p>Issued by Amy L. Timperley Senior Vice President/ Chief Regulatory Officer</p>	
--	---	--

N
N

T
T
T

SCHEDULE NO. SG-EG/NG-EG

SMALL ELECTRIC GENERATION GAS SERVICE
(Continued)

SPECIAL CONDITIONS

1. A service agreement shall be required under this schedule for customers with certified capacity of over 100 kW and shall contain the volumetric entitlement by curtailment priority as defined in NAC 704.501.
2. To initiate service under this schedule, customers who presently take transportation or alternative sales service under Schedule Nos. ST-1/NT-1 or SG-AS/NG-AS must make a three-year commitment to sales service.
3. Customers under this schedule may elect transportation service after providing an 18 month notification; however, customers with an active sales service agreement can return to transportation service only at the conclusion of their sales service agreement after providing at least 18 months notice.

Customers who switch to transportation service without providing proper notice will be assessed an exit fee to prevent the shifting of any costs to its remaining sales customers, if the Company determines there are such costs associated with the customer's change in service.

4. Upon switching from transportation service to sales service under this schedule, the Base Tariff Energy Rate (BTER) of the customer's sales rate will be the higher of the following charges for the initial 12 month sales period:
 - (i) The BTER of the Currently Effective Tariff Rate; or
 - (ii) The monthly weighted average cost of gas, including an assessment for interstate capacity costs, incurred by the Company.

<p>Issued: December 31, 2018</p> <p>Effective: January 1, 2019</p> <p>Advice Letter No.:</p>	<p>Issued by Justin Lee Brown Senior Vice President</p>	
--	---	--

SCHEDULE NO. SG-EG/NG-EG

SMALL ELECTRIC GENERATION GAS SERVICE
(Continued)

SPECIAL CONDITIONS (Continued)

The customer's sales rate will be adjusted to exclude the Deferred Energy Account Adjustment (DEAA) for the initial 12 month sales period. After the conclusion of the initial twelve 12 month sales period, the customer shall be billed at the Currently Effective Tariff Rate.

5. Gas service under this schedule is not available for "standby" or occasional temporary service.
6. The term "otherwise applicable gas sales tariff schedule" as used herein excludes all optional tariff schedules.

BASE TARIFF ENERGY RATE (BTER) AND DEFERRED ENERGY ACCOUNT ADJUSTMENT (DEAA)

The rates specified for this schedule are subject to increases or decreases in the cost of purchased gas in accordance with those provisions set forth in Chapter 704 of the NAC.

GENERAL TERMS AND CONDITIONS

Except as qualified in this schedule, all of the General Terms and Conditions are applicable to this schedule and are hereby made a part hereof.

<p>Issued: December 31, 2018</p> <p>Effective: January 1, 2019</p> <p>Advice Letter No.:</p>	<p>Issued by Justin Lee Brown Senior Vice President</p>	
--	---	--

SCHEDULE NO. SG-CNG/NG-CNG

GAS SERVICE FOR COMPRESSION ON CUSTOMER'S PREMISES

APPLICABILITY

Applicable to gas service for the sole purpose of compressing natural gas for use as a fuel in vehicular internal combustion engines.

Service under this schedule shall be through one or more meters at the option of the Company, provided they are located at the same premise. Service for any end use of gas other than the compression of natural gas for vehicle use, such as space heating, water heating, processing or boiler fuel use, is not permitted under this schedule nor through the meter(s) through which service under this schedule is provided.

TERRITORY

Throughout the Company's certificated Nevada Service Areas, except as may hereafter be provided.

RATES

The commodity charge and Basic Service Charge are set forth in the currently effective Statement of Rates of this Nevada Gas Tariff and are incorporated herein by reference.

For transportation customers electing to switch to sales service under this schedule, the Base Tariff Energy Rate (BTER) of the customer's sales rate will be determined in accordance with Special Condition No. 4 of this schedule.

The minimum charge per month is the Basic Service Charge.

LATE CHARGE

The monthly bill is due and payable as of the date of presentation. Included in the bill will be a late charge of five percent on the first \$200 of the monthly bill, plus two percent of any balance above \$200, which will be imposed if payment is not received by the next month's billing.

<p>Issued: December 31, 2018</p> <p>Effective: January 1, 2019</p> <p>Advice Letter No.:</p>	<p>Issued by Justin Lee Brown Senior Vice President</p>	
--	---	--

SCHEDULE NO. SG-CNG/NG-CNG

GAS SERVICE FOR COMPRESSION ON CUSTOMER'S PREMISES
(Continued)

SPECIAL CONDITIONS

1. A service agreement specifying the customer's volumetric requirements and curtailment priority as defined in NAC 704.501 may be required under this schedule.
2. To initiate service under this schedule, customers who presently take transportation or alternative sales service under Schedule Nos. ST-1/NT-1 or SG-AS/NG-AS must make a three-year commitment to sales service.
3. Customers under this schedule may elect transportation service after providing an 18 month notification; however, customers with an active sales service agreement can return to transportation service only at the conclusion of their sales service agreement after providing at least 18 months notice.

Customers who switch to transportation service without providing proper notice will be assessed an exit fee to prevent the shifting of any costs to its remaining sales customers, if the Company determines there are such costs associated with the customer's change in service.

4. Upon switching from transportation service to sales service under this schedule, the Base Tariff Energy Rate (BTER) of the customer's sales rate will be the higher of the following charges for the initial 12 month sales period:
 - (i) The BTER of the Currently Effective Tariff Rate; or
 - (ii) The monthly weighted average cost of gas, including an assessment for interstate capacity costs, incurred by the Company.

The customer's sales rate will be adjusted to exclude the Deferred Energy Account Adjustment (DEAA) for the initial 12 month sales period. After the conclusion of the initial 12 month sales period, the customer shall be billed at the Currently Effective Tariff Rate.

<p>Issued: December 31, 2018</p> <p>Effective: January 1, 2019</p> <p>Advice Letter No.:</p>	<p>Issued by Justin Lee Brown Senior Vice President</p>	
--	---	--

SCHEDULE NO. SG-CNG/NG-CNG

GAS SERVICE FOR COMPRESSION ON CUSTOMER'S PREMISES
(Continued)

SPECIAL CONDITIONS (Continued)

5. For service rendered under this schedule to residential customers, the Basic Service Charge applicable to this schedule shall be the residential Basic Service Charge as set forth in the currently effective Statement of Rates of this Nevada Gas Tariff.
6. Customers may receive service under this schedule separately or in combination with another schedule. Where service is rendered in combination with another schedule, a separate monthly Basic Service Charge shall be applicable for service under each schedule.

BASE TARIFF ENERGY RATE (BTER) AND DEFERRED ENERGY ACCOUNT ADJUSTMENT (DEAA)

The rates specified for this schedule are subject to increases or decreases in the cost of purchased gas in accordance with those provisions set forth in Chapter 704 of the NAC.

GENERAL TERMS AND CONDITIONS

Except as qualified in this schedule, all of the General Terms and Conditions are applicable to this schedule and are hereby made a part hereof.

<p>Issued: December 31, 2018</p> <p>Effective: January 1, 2019</p> <p>Advice Letter No.:</p>	<p>Issued by Justin Lee Brown Senior Vice President</p>	
--	---	--

SCHEDULE NO. SG-L/NG-L

STREET AND OUTDOOR LIGHTING GAS SERVICE

APPLICABILITY

Applicable to gas service for continuous street or outdoor lighting in lighting devices approved by the Company. Service under this schedule is conditional upon arrangements mutually satisfactory to the customer and the Company for connection of customer's lighting devices to Company's facilities.

This schedule is closed to applications for new service connection to the Company's distribution system or for service reconnection where the lighting device has previously been physically disconnected from the Company's distribution system.

TERRITORY

Throughout the Company's certificated Nevada Service Areas, except as may hereafter be provided.

RATES

The charge per month is the product of the therms per month per mantle and the commodity charge as set forth in the currently effective Statement of Rates of this Nevada Gas Tariff.

LATE CHARGE

The monthly bill is due and payable as of the date of presentation. Included in the bill will be a late charge of five percent on the first \$200 of the monthly bill, plus two percent of any balance above \$200, which will be imposed if payment is not received by the next month's billing.

<p>Issued: December 31, 2018</p> <p>Effective: January 1, 2019</p> <p>Advice Letter No.:</p>	<p>Issued by Justin Lee Brown Senior Vice President</p>	
--	---	--

T

T

SCHEDULE NO. SG-L/NG-L

STREET AND OUTDOOR LIGHTING GAS SERVICE
(Continued)

SPECIAL CONDITIONS

1. At its sole option, the Company may reduce the maximum rated capacity to reflect use of automatic dimmer devices or adjustment of the lamps to operate at less than the maximum rated capacity.
2. All piping upstream of the customer's meter for connection of lighting devices to the Company's facilities must be installed by the Company and shall be owned, operated and maintained by the Company.
3. Discontinuance of street and outdoor lighting gas service: Upon receipt of a request for a discontinuance of service to street or outdoor lighting devices, the Company shall discontinue service to the customer's lighting device(s) pursuant to Rule No. 6A of this Nevada Gas Tariff. The Company will reinitiate service to the lighting device(s) if requested by subsequent application. If the customer wishes to convert to an alternate lighting source such as solar, low voltage or 110v electric, the customer must provide advance notice to the Company. At the request of the customer, the Company will provide a document of conveyance of title and ownership of the concrete support base assembly and associated appurtenances, excluding the valve and riser. Such facilities shall be conveyed in the as-is, where-is condition, with all faults and free of any express or implied warranties. The Company shall not be liable for any claims arising from or connected with such facilities.
4. Permanent disconnection of street and outdoor lighting gas service: At the request of the customer and payment of the charge as set forth in the Statement of Rates Other Service Charges in this Nevada Gas Tariff, the Company shall permanently disconnect the lighting device from the Company's distribution system and abandon such facilities in place. The following conditions will apply:
 - a. The customer is responsible for any applicable permits;

<p>Issued: December 31, 2018</p> <p>Effective: January 1, 2019</p> <p>Advice Letter No.:</p>	<p>Issued by Justin Lee Brown Senior Vice President</p>	
--	---	--

SCHEDULE NO. SG-L/NG-L

STREET AND OUTDOOR LIGHTING GAS SERVICE
(Continued)

SPECIAL CONDITIONS (Continued)

- b. The customer must comply with all applicable regulations including, but not limited to, requesting all operators of subsurface installations to locate and mark their subsurface installations that are installed in the vicinity of each excavation;
- c. The customer must excavate the gas line connecting the lighting device to the Company distribution system with hand tools at the point specified by the Company;
- d. The customer is responsible for ensuring that all appropriate safety measures are employed when the excavation is unattended;
- e. The Company will cut and cap the gas line and install sand or other non-injurious embedment in the excavation to cover the gas line;
- f. The customer is responsible for backfilling and compacting the excavation area after the gas line has been cut and capped;
- g. The customer is responsible for any landscape restoration, concrete or asphalt repairs and removal of excess material; and
- h. Title and ownership of the Company's facilities abandoned in place will be conveyed to the customer upon the permanent physical disconnection of the lighting device from the Company's distribution system. All such facilities are conveyed in the as-is, where-is condition, with all faults and free of any express or implied warranties. The Company shall not be liable for any claims arising from or connected with such facilities. After a lighting device has been permanently disconnected from the distribution system, it cannot be reconnected at a later date.

<p>Issued: November 10, 2009</p> <p>Effective: November 1, 2009</p> <p>Advice Letter No.:</p>	<p>Issued by John P. Hester Senior Vice President</p>	
---	---	--

SCHEDULE NO. SG-L/NG-L

STREET AND OUTDOOR LIGHTING GAS SERVICE
(Continued)

SPECIAL CONDITIONS *(Continued)*

5. Customer requested relocation, removal or abandonment of street and outdoor lighting facilities: The Company will, at the customer's request, relocate, remove or abandon in place gas lighting devices and related facilities. Such relocation, removal or abandonment shall be performed by the Company at the expense of the customer. The Company will furnish a written estimate to the customer for all work to be completed and the customer shall pay the full amount of the estimate to the Company before the work is started. At the conclusion of the relocation, removal or abandonment, the Company shall refund any overestimated amount, or bill the customer for any underestimated amount.

BASE TARIFF ENERGY RATE (BTER) AND DEFERRED ENERGY ACCOUNT ADJUSTMENT (DEAA)

The rates specified for this schedule are subject to increases or decreases in the cost of purchased gas in accordance with those provisions set forth in Chapter 704 of the NAC.

GENERAL TERMS AND CONDITIONS

Except as qualified in this schedule, all of the General Terms and Conditions are applicable to this schedule and are hereby made a part hereof.

<p>Issued: December 31, 2018</p> <p>Effective: January 1, 2019</p> <p>Advice Letter No.:</p>	<p>Issued by Justin Lee Brown Senior Vice President</p>	
--	---	--

Schedule No. SG-CGS/NG-CGS

COMPRESSION GAS SERVICE

APPLICABILITY

Applicable to qualified non-residential Applicants requiring compressed natural gas (CNG). Compression Services will be provided by Utility ownership and operation of Compression Facilities located on Applicant's premises and will allow for the resale of CNG by qualified Applicants. Service under this schedule is conditional upon arrangements mutually satisfactory to the Applicant and the Utility for design, location, construction, and operation of required Compression Facilities. All such arrangements will be incorporated into a Compression Services Agreement and will be separately metered.

TERRITORY

Throughout the Company's certificated Nevada Service Areas, except as may hereafter be provided.

RATES

The charge for this service will be in addition to the charges for gas delivery service required to deliver the gas to the Applicant's premise. The delivery charges are set forth in the Applicant's applicable gas sales tariff schedule or the charges set forth in the Applicant's service agreement.

The Utility and Applicant will negotiate a rate structure based on the Utility's cost of service and shall recover costs including, but not limited to, depreciation, return on capital investment, income taxes, property taxes, and operational expenses. Contract agreements qualifying for service under this Rate Schedule, shall be subject to review and approval by the Commission. In the event of early termination of the Compression Services Agreement, the Utility shall recover from Applicant an amount based on the Utility's unrecovered ownership and removal costs and any early termination provisions in the Applicant's Compression Services Agreement.

<p>Issued: December 31, 2018</p> <p>Effective: January 1, 2019</p> <p>Advice Letter No.:</p>	<p>Issued by Justin Lee Brown Senior Vice President</p>	
--	---	--

Schedule No. SG-CGS/NG-CGS

COMPRESSION GAS SERVICE

(Continued)

GENERAL REQUIREMENTS

1. DESIGN. The Utility will be responsible for planning, designing, procuring, installing, and constructing the Compression Facilities according to the Utility's design, engineering and construction standards.
2. OWNERSHIP OF COMPRESSION FACILITIES. The Compression Facilities installed under the provisions of this schedule shall be owned, operated, and maintained by the Utility. Applicant shall own, operate, and maintain any and all equipment and facilities beyond the point of delivery of the CNG.
3. PLACEMENT OF COMPRESSION FACILITIES AND RIGHTS-OF-WAY. Applicant shall provide an appropriate location and Protective Structures for the safe and secure placement and operation of Compression Facilities as required by the Utility. Applicant shall provide the Utility rights-of-way, leases and/or easements, as required by the Utility to install, maintain, and operate Compression Facilities on Applicant's premises and to furnish Compression Services to Applicant.
4. ACCESS TO APPLICANT'S PREMISES. The Utility shall at all times have the right of ingress to and egress from Applicant's premises for any purpose connected with the furnishing of Compression Services or other gas services and the exercise of any and all rights secured to it by law, or under this tariff. These rights include, but are not limited to:
 - i. The use of a Utility-approved locking device to prevent unauthorized access to the Utility's facilities;
 - ii. Safe and ready access for Utility personnel, free from unrestrained animals;
 - iii. Unobstructed ready access for the Utility's vehicles and equipment to install, operate, remove, repair, or maintain Compression Facilities; and
 - iv. Removal of any and all of the Utility's property installed on or below Applicant's premises after the termination of Compression Services.

<p>Issued: December 31, 2018 Effective: January 1, 2019 Advice Letter No.:</p>	<p>Issued by Justin Lee Brown Senior Vice President</p>	
--	---	--

Schedule No. SG-CGS/NG-CGS

COMPRESSION GAS SERVICE
(Continued)

GENERAL REQUIREMENTS (Continued)

5. SERVICE CONNECTIONS. Only personnel duly authorized by the Utility are allowed to connect or disconnect Compression Facilities to or from the Point of Delivery, remove Compression Facilities, or perform any work upon Compression Facilities or the existing Utility-owned facilities.

APPLICANT RESPONSIBILITIES

In accordance with the Utility's design, specifications, and requirements for the installation, maintenance and operation of Compression Facilities, Applicant shall have the following responsibilities:

1. Applicant shall be solely responsible for electric service and all electric bills and electric costs, including electricity to run Compression Facilities, during construction and operating periods, and all other utility services required for the construction and/or operation of the Compression Facilities.
2. Applicant shall, at Applicant's sole liability, risk and expense, plan, design, construct, install, own, maintain, and operate facilities and equipment beyond the Compression Point of Delivery in order to properly receive and dispense compressed natural gas, including, but not limited to, fast fill dispensers, time fill posts and hoses, and any required high pressure piping, fittings, valves, regulators, appliances, fixtures, and apparatus of any kind or character required for interconnection with Compression Facilities, all of which shall conform to industry standards and applicable laws, codes, and ordinances of all governmental authorities having jurisdiction, including any applicable environmental laws. Detailed information on the Utility's service equipment requirements will be furnished to Applicant by the Utility.
3. Applicant shall make arrangements to shut down the operation of existing equipment as needed to allow the Utility to tie into existing gas piping (both on the supply side and on the high-pressure side), to tie into the electrical system to provide power to the Compression Facilities, to tie into the existing grounding system, and to tie into existing control/emergency systems.

<p>Issued: December 31, 2018</p> <p>Effective: January 1, 2019</p> <p>Advice Letter No.:</p>	<p>Issued by Justin Lee Brown Senior Vice President</p>	
--	---	--

Schedule No. SG-CGS/NG-CGS

COMPRESSION GAS SERVICE

(Continued)

APPLICANT RESPONSIBILITIES *(Continued)*

4. Applicant shall: (i) limit access and take all necessary steps to prevent Compression Facilities from being damaged or destroyed; (ii) not interfere with the Utility's ongoing operation of Compression Facilities; and (iii) provide adequate notice to the Utility through the Utility's representative identified in the Compression Services Agreement prior to any inspection of Compression Facilities by regulatory agencies.
5. The Utility shall incur no liability whatsoever, for any damage, loss, or injury occasioned by or resulting from:
 - i. The selection, installation, operation, maintenance or condition of Applicant's facilities or equipment; or
 - ii. The negligence, omission of proper shut-off valves or other protective and safety devices, want of proper care, or wrongful act of Applicant, or any agents, employees, or licensees of Applicant, on the part of Applicant installing, maintaining, using, operating, or interfering with its own pipes, fittings, valves, regulators, appliances, fixtures, or apparatus.
6. Applicant shall meet all Utility requirements regarding creditworthiness and insurance.

<p>Issued: December 31, 2018</p> <p>Effective: January 1, 2019</p> <p>Advice Letter No.:</p>	<p>Issued by Justin Lee Brown Senior Vice President</p>	
--	---	--

Schedule No. SG-CGS/NG-CGS

COMPRESSION GAS SERVICE

(Continued)

APPLICANT RESPONSIBILITIES (Continued)

7. Applicant shall indemnify, defend and hold harmless the Utility and its authorized officers, employees, and agents from any and all claims, actions, losses, damages and/or liability of every kind and nature in any way connected with or resulting from the violation or noncompliance with any local, state, or federal environmental law or regulation as a result of pre-existing conditions at the premises, release or spill of any pre-existing hazardous materials or waste, or out of the management and disposal of any pre-existing contaminated soils or groundwater, hazardous or nonhazardous, removed from the ground as a result of the Compression Services or Compression Facilities ("Pre-Existing Environmental Liability"), including, but not limited to, liability for the costs, expenses, and legal liability for environmental investigations, monitoring, containment, abatement, removal, repair, cleanup, restoration, remedial work, penalties, and fines arising from the violation of any local, state, or federal law or regulation, attorney's fees, disbursements, and other response costs. As between Applicant and the Utility, Applicant agrees to accept full responsibility for and bear all costs associated with Pre-Existing Environmental Liability. Applicant agrees that the Utility may stop work, terminate Compression Services, redesign the Compression Facilities to a different location or take other action reasonably necessary to install the Compression Facilities without incurring any Pre-Existing Environmental Liability.

8. Applicant shall be responsible for the additional costs required to modify or maintain Compression Facilities or to provide Compression Services due to any changes in local, state or federal laws, regulations or permit requirements.

<p>Issued: December 31, 2018</p> <p>Effective: January 1, 2019</p> <p>Advice Letter No.:</p>	<p>Issued by Justin Lee Brown Senior Vice President</p>	
--	---	--

Schedule No. SG-CGS/NG-CGS

COMPRESSION GAS SERVICE
(Continued)

UTILITY RESPONSIBILITIES

1. The Utility shall plan, design, procure, install, construct, own, operate, and maintain Compression Facilities sufficient to provide Compression Services to Applicant.
2. The Utility shall apply for any permits necessary to construct and operate the Compression Facilities; however Applicant shall be responsible, at its own cost and expense without any dollar contribution or reimbursement from Utility, for any modification(s) to premises required by any permit.
3. The Utility or its subcontractor shall operate the Compression Facilities and shall perform preventative maintenance, including regular inspections, on Compression Facilities consistent with the manufacturer's recommendations and regulatory requirements.
4. The Utility shall remove Compression Facilities at the end of the term of the Compression Services Agreement or any extensions thereof, and Applicant shall allow the Utility a sufficient amount of time to complete removal of Compression Facilities.

SPECIAL CONDITIONS

1. Service may be denied, suspended or discontinued for nonpayment, unsafe apparatus, or other reasons in accordance with Rule No. 6, Discontinuance, Termination, Restoration and Refusal of Service.
2. Any disputed bill will be treated in accordance with Rule No. 14, Disputed Bills
3. All tariff rules shall apply unless they conflict with the terms of this schedule. Whenever possible, the tariff rules and this schedule shall be interpreted in such a way as to reconcile and give meaning to all terms therein, if reconciliation can be accomplished by any reasonable interpretation.

<p>Issued: December 31, 2018 Effective: January 1, 2019 Advice Letter No.:</p>	<p>Issued by Justin Lee Brown Senior Vice President</p>	
--	---	--

Schedule No. SG-CGS/NG-CGS

COMPRESSION GAS SERVICE

(Continued)

SPECIAL CONDITIONS *(Continued)*

4. As a condition precedent to service under this schedule, a fully executed Compression Services Agreement is required. All contracts, rates and conditions are subject to revision and modification as a result of Commission order.
5. At the end of the term of the Compression Services Agreement and assuming that all required payments have been made by Applicant, the parties may mutually agree to extend the term of the Compression Services Agreement for a period to be mutually agreed upon.
6. Utility may file in the public records, including real estate records, such instruments as may be appropriate or desirable (such as Uniform Commercial Code financing statements and fixture filings) to put others on notice of Utility's ownership of the Compression Facilities.
7. Applicant may request changes to Compression Services or Compression Facilities as a result of changes to Applicant's compression requirements at any time during the term of the Compression Services Agreement; however, Utility has sole discretion whether to make any changes to Compression Services or Compression Facilities, and Applicant shall be responsible for the full costs related to any such changes in Compression Services or Compression Facilities.

<p>Issued: December 31, 2018</p> <p>Effective: January 1, 2019</p> <p>Advice Letter No.:</p>	<p>Issued by Justin Lee Brown Senior Vice President</p>	
--	---	--

Schedule No. SG-CGS/NG-CGS

COMPRESSION GAS SERVICE
(Continued)

DEFINITIONS

1. **COMPRESSION FACILITIES.** Facilities to be placed on Applicant's premises in order to provide Compression Services (to be identified in Exhibit A of the Compression Services Agreement) may include, but are not limited to:
 - i. Compressors, gas dryers, storage vessels, and any other equipment needed to supply gas pressure to Applicant's facilities at times and levels required by Applicant's operations;
 - ii. Integrated equipment that includes peripheral equipment related to Applicant's specific application; and
 - iii. Other associated equipment that may be requested by Applicant and agreed to by Utility.
2. **COMPRESSION POINT OF DELIVERY.** The point where pipes owned, leased, or under license by a customer and which are subject to inspection by the appropriate city, county, or state authority connect to the Utility's compression equipment or at the high pressure side of a valve or meter, whichever is further downstream. When there is more than one high pressure valve or meter, it is the point where the pipes owned, leased, or under license by a customer and which are subject to inspection by the appropriate city, county, or state authority connect to the Utility's compression equipment that are connected to the upstream high pressure valve or meter or at the outlet side of the upstream high pressure valve or meter, whichever is further downstream.
3. **COMPRESSION SERVICES.** Compression of natural gas delivered to the Applicant by the Utility to levels agreed upon by both the Utility and Applicant through the use of Compression Facilities located on Applicant's Premises.

<p>Issued: December 31, 2018 Effective: January 1, 2019 Advice Letter No.:</p>	<p>Issued by Justin Lee Brown Senior Vice President</p>	
--	---	--

Schedule No. SG-CGS/NG-CGS

COMPRESSION GAS SERVICE
(Continued)

DEFINITIONS (Continued)

4. **COMPRESSION SERVICES AGREEMENT.** Agreement between Applicant and Utility describing Compression Services to be provided to Applicant and Compression Facilities to be installed by Utility, subject to this Schedule and all applicable tariff schedules as filed from time to time with the Commission.

5. **PROTECTIVE STRUCTURES.** Fences, retaining walls (in lieu of grading), barriers, posts, barricades and other structures as required by Utility, permitting agencies, or other regulations.

<p>Issued: December 31, 2018 Effective: January 1, 2019 Advice Letter No.:</p>	<p>Issued by Justin Lee Brown Senior Vice President</p>	
--	---	--

N
N

SCHEDULE NO. SG-OS/NG-OS

OPTIONAL GAS SERVICE

APPLICABILITY

Applicable to natural gas use by general gas service customers whose requirements are at least 500 therms per day on an annualized basis and who qualify for service under this schedule according to either Applicability provision (1) or (2) herein:

1. General gas service customers who have installed facilities capable of burning alternate fuels or energy.
2. General gas service customers whose requirements may be served by other natural gas suppliers at rates lower than the customer's otherwise applicable gas sales tariff schedule. As a condition precedent to qualifying for service under this Applicability provision, the customer must qualify for transportation service under Schedule No. ST-1/NT-1 and establish that bypass is economically, operationally and physically feasible and imminent. In addition, prior to initiating service under this Applicability provision, the Company shall file the executed service agreement and supporting economic studies with the Commission.

This optional schedule is not available for partial requirements gas service where gas is utilized in combination with alternate fuels or energy. Any gas service rendered to customers not in conformance with the provisions of this schedule shall be billed under the otherwise applicable gas sales tariff schedule.

TERRITORY

Throughout the Company's certificated Nevada Service Areas, except as may hereafter be provided.

<p>Issued: November 10, 2009</p> <p>Effective: November 1, 2009</p> <p>Advice Letter No.:</p>	<p>Issued by John P. Hester Senior Vice President</p>	
---	---	--

SCHEDULE NO. SG-OS/NG-OS

OPTIONAL GAS SERVICE
(Continued)

RATES

The Basic Service Charge is the charge under the otherwise applicable gas sales tariff schedule in the currently effective Statement of Rates of this Nevada Gas Tariff and is incorporated herein by reference.

The commodity charge per therm shall be determined in accordance with Special Condition (1) or (2) and the paragraphs below describing the accounting for purchased gas costs.

The minimum charge per month is the Basic Service Charge, unless otherwise provided in the executed service agreement with the customer.

For the purpose of accounting for purchased gas costs for sales to general gas service customers under this schedule, the Company shall use the monthly average actual purchased gas cost per therm. If using the monthly average actual purchased gas cost per therm results in a zero or negative margin in the total commodity sales rate, the Company shall reduce the upstream pipeline reservation charge component of the gas cost so that the margin in the total commodity sales rate is greater than zero, and so that the commodity sales rate fully recovers appropriate purchased gas commodity and reservation charges. The cost of purchased gas used for accounting purposes shall not be less than the actual monthly average commodity purchased gas cost per therm, plus some portion of the upstream pipeline reservation charge.

LATE CHARGE

The monthly bill is due and payable as of the date of presentation. Included in the bill will be a late charge of five percent on the first \$200 of the monthly bill, plus two percent of any balance above \$200, which will be imposed if payment is not received by the next month's billing.

<p>Issued: December 31, 2018</p> <p>Effective: January 1, 2019</p> <p>Advice Letter No.:</p>	<p>Issued by Justin Lee Brown Senior Vice President</p>	
--	---	--

SCHEDULE NO. SG-OS/NG-OS

OPTIONAL GAS SERVICE
(Continued)

SPECIAL CONDITIONS

1. The commodity charge per therm for customers served hereunder may vary from customer to customer based on value of the service, the market price of alternate fuels and on the customer's ability to change from one fuel to another, and may be increased or decreased as costs and conditions change.
2. Prior to the establishment of service under this schedule, the customer shall execute a service agreement.
3. Customers that qualify for service under Applicability provision (1) hereof must have and maintain adequate alternate fuel standby facilities of equivalent capacity to those natural gas facilities served hereunder. These facilities are subject to Company inspection and verification of operating capacity and capability.
4. In no event shall the cost of gas assigned to sales under this schedule result in an economic detriment to the Company's system.
5. The term "otherwise applicable gas sales tariff schedule" as used herein excludes transportation tariff schedules.
6. Alternate fuel capable customers served under this schedule may be asked by the Company to voluntarily switch to their alternate fuel source. In such an event the Company shall credit to the customer the incremental cost of the alternate fuel, i.e., the difference between the actual cost of using the alternate fuel and the currently effective rate for natural gas purchased under this schedule. Such credit shall be applied to the Company's next scheduled billing after customer has furnished adequate proof to the Company concerning replacement quantities and incremental costs. The Company reserves the right to verify alternate fuel consumption and cost and to quantify the associated reduction in deliveries of natural gas for the period requested by the Company. This provision shall not apply when higher priority (numerically lower priority number) customers are being curtailed or when curtailment quantities exceed the aggregate quantities displaced by alternate fuel under this provision.

<p>Issued: December 31, 2018</p> <p>Effective: January 1, 2019</p> <p>Advice Letter No.:</p>	<p>Issued by Justin Lee Brown Senior Vice President</p>	
--	---	--

T
T
T

T

SCHEDULE NO. SG-OS/NG-OS

OPTIONAL GAS SERVICE
(Continued)

GENERAL TERMS AND CONDITIONS

1. Except as qualified in this schedule, all of the General Terms and Conditions are applicable to this schedule and are hereby made a part hereof.
2. All service under this schedule will be provided in accordance with the provisions of NAC 704.516 through NAC 704.528, except as otherwise provided for in this Nevada Gas Tariff.

<p>Issued: December 31, 2018</p> <p>Effective: January 1, 2019</p> <p>Advice Letter No.:</p>	<p>Issued by Justin Lee Brown Senior Vice President</p>	
--	---	--

SCHEDULE NO. SG-AS/NG-AS

ALTERNATIVE SALES SERVICE

APPLICABILITY

Applicable to transportation-eligible customers who do not elect to receive sales service under their otherwise applicable sales rate schedule.

TERRITORY

Throughout the Company's certificated Nevada Service Areas, except as may hereafter be provided.

RATES

The Basic Service Charge, commodity charge and demand charge, if applicable, are set forth under the customer's otherwise applicable gas sales tariff schedule, which are set forth in the currently effective Statement of Rates of this Nevada Gas Tariff and are incorporated herein by reference.

For transportation customers electing to switch to sales service under this schedule, the Base Tariff Energy Rate (BTER) of the customer's sales rate will be determined in accordance with Special Condition No. 2 of this schedule.

The minimum charge per month is the sum of the Basic Service Charge and the demand charge, if applicable.

LATE CHARGE

The monthly bill is due and payable as of the date of presentation. Included in the bill will be a late charge of five percent on the first \$200 of the monthly bill, plus two percent of any balance above \$200, which will be imposed if payment is not received by the next month's billing.

<p>Issued: December 31, 2018</p> <p>Effective: January 1, 2019</p> <p>Advice Letter No.:</p>	<p>Issued by Justin Lee Brown Senior Vice President</p>	
--	---	--

SCHEDULE NO. SG-AS/NG-AS

ALTERNATIVE SALES SERVICE
(Continued)

SPECIAL CONDITIONS

1. Customers electing to switch to alternative sales service under this schedule will be required to enter into a service agreement with the Company. Existing alternative sales customers are required to notify the Company if they desire to elect service under their otherwise applicable sales schedule. The election must be submitted to the Company no later than April 1 of each year for sales service commencing the following November 1.
2. Upon switching from transportation service to sales service under this schedule, the Base Tariff Energy Rate (BTER) of the customer's sales rate will be the higher of the following charges for the initial 12 month sales period:
 - (i) The BTER of the Currently Effective Tariff Rate; or
 - (ii) The monthly weighted average cost of gas, including an assessment for interstate capacity costs, incurred by the Company.

The customer's sales rate will be adjusted to exclude the Deferred Energy Account Adjustment (DEAA) for the initial 12 month sales period. After the conclusion of the initial 12 month sales period, the customer shall be billed at the Currently Effective Tariff Rate.

3. Under this schedule, the Company is not obligated to secure resources upstream of the distribution system. Curtailment shall be according to Section C.2 of Rule 8 of this Nevada Gas Tariff.
4. The term "otherwise applicable gas sales tariff schedule" as used herein excludes all optional tariff schedules.
5. All remaining terms and conditions of the customer's otherwise applicable gas sales schedule shall apply to service under this schedule and are incorporated herein by reference.

<p>Issued: December 31, 2018</p> <p>Effective: January 1, 2019</p> <p>Advice Letter No.:</p>	<p>Issued by Justin Lee Brown Senior Vice President</p>	
--	---	--

Schedule No. SG-RNG/NG-RNG

BIOGAS AND RENEWABLE NATURAL GAS SERVICE

APPLICABILITY

Applicable to non-residential suppliers of Biogas and suppliers of Renewable Natural Gas (RNG) ("Applicant"). This schedule provides the general terms and conditions that apply to the Applicant(s) and their interconnection to the Utility's facilities and the Utility's receipt of Biogas or RNG into its facilities from such interconnection point(s).

TERRITORY

Throughout the Company's certificated Nevada Service Areas, except as may hereafter be provided.

RATES

The Utility and Applicant(s) will negotiate a mutually agreeable rate structure based on the Utility's cost of service ("Services Fee"), which includes depreciation, return on capital investment, taxes, and operational expenses. The Services Fee shall be set forth in negotiated agreements dependent upon the type of service provided by the Utility such as; a) Biogas Gathering Agreement ("Gathering Agreement"), b) Biogas Cleaning and Upgrading Agreement ("Upgrading Agreement") or c) RNG Interconnection and Transportation Agreement ("RNG Transportation Agreement"), or any other applicable agreement required to effectuate service under this tariff. Contract agreements qualifying for service under this Rate Schedule, shall be subject to review and approval by the Commission.

The Services Fee will be in addition to the charges for gas delivery service required to deliver gas from the interconnection point(s) to another location on the Utility's facilities. The delivery charges are set forth in the Applicant's applicable gas sales service tariff schedule or the charges set forth in the Applicant's service agreement.

<p>Issued: December 31, 2018</p> <p>Effective: January 1, 2019</p> <p>Advice Letter No.:</p>	<p>Issued by Justin Lee Brown Senior Vice President</p>	
--	---	--

N
N

Schedule No. SG-RNG/NG-RNG

BIOGAS AND RENEWABLE NATURAL GAS SERVICE
(Continued)

BIOGAS SERVICE

ACCESS TO UTILITY-OWNED BIOGAS FACILITIES AND INTERCONNECTION POINTS

The Applicant(s) and the Utility shall execute an operating and/or other necessary agreement(s) prior to the interconnection and commencement of Biogas flowing into Utility-Owned Biogas Facilities. Upon written agreement between Applicant(s) and Utility, Utility shall provide the Applicant(s) access to Utility-Owned Biogas Facilities at a Biogas interconnection point, according to the provisions of that agreement(s) and this tariff. Terms of access to Utility-Owned Biogas Facilities and Biogas interconnection points will be determined by the agreement(s) between Applicant(s) and Utility. Nothing in this provision shall be interpreted as creating a requirement that the Utility gather, clean, upgrade or purchase any Biogas. Further, nothing in this provision shall be interpreted as requiring Utility to enter a written agreement with Applicant(s) for access to Utility-Owned Biogas Facilities.

RENEWABLE NATURAL GAS SERVICE

If any of the RNG tendered for receipt into the Utility's facilities fails at any time to conform to the quality specifications set forth between the Utility and the Applicant(s), the Utility may refuse to accept receipt of non-conforming RNG. The Utility's refusal to accept non-conforming RNG does not relieve the Applicant of any of its obligations under this tariff or its agreements with the Utility. The Utility will notify the Applicant when the Applicant's RNG does not conform to Utility specifications. However, such notification does not relieve the Applicant of its responsibility to monitor test results and to take corrective action if needed. The Utility may elect to accept non-conforming RNG at its sole discretion. The Utility's acceptance of RNG that does not conform to these specifications does not constitute a waiver of the Utility's right to refuse to accept similarly non-conforming RNG.

ACCESS TO APPLICANT'S PREMISES.

The Utility shall at all times have the right of ingress to and egress from Applicant's premises for any purpose connected with the furnishing of Biogas and Renewable Natural Gas services or other gas services and the exercise of any and all rights secured to it by law, or under this tariff.

<p>Issued: December 31, 2018</p> <p>Effective: January 1, 2019</p> <p>Advice Letter No.:</p>	<p>Issued by Justin Lee Brown Senior Vice President</p>	
--	---	--

Schedule No. SG-RNG/NG-RNG

BIOGAS AND RENEWABLE NATURAL GAS SERVICE
(Continued)

RENEWABLE NATURAL GAS SERVICE (continued)

1. RENEWABLE NATURAL GAS SPECIFICATIONS

- i. RNG received into the Utility's system shall conform to the gas quality specifications identified in the Agreement at the time of receipt.
- ii. RNG must not contain hazardous substances at concentration levels which would prevent or unduly impact the merchantability of RNG, be injurious to Utility facilities, or which would present a health and/or safety hazard to Utility employees, customers, and/or the public.
- iii. Source-specific RNG Testing shall vary based on the source of the RNG:
 - a. RNG sourced from non-hazardous waste facilities shall be tested for all Health and Pipeline Integrity Protective Constituents.
 - b. RNG sourced from dairies shall be tested for Ethylbenzene, Hydrogen Sulfide, n-Nitroso-di-n-propylamine, Mercaptans, Toluene and all Health and Pipeline Integrity Protective Constituents.
 - c. RNG sourced from public- or private-owned treatment works (water and sewage treatment plants) and other sources of RNG shall be tested for p-Dichlorobenzene, Ethylbenzene, Hydrogen Sulfide, Mercaptans, Toluene, Vinyl Chloride, and all Health and Pipeline Integrity Protective Constituents.

<p>Issued: December 31, 2018</p> <p>Effective: January 1, 2019</p> <p>Advice Letter No.:</p>	<p>Issued by Justin Lee Brown Senior Vice President</p>	
--	---	--

Schedule No. SG-RNG/NG-RNG

BIOGAS AND RENEWABLE NATURAL GAS SERVICE
(Continued)

RENEWABLE NATURAL GAS SERVICE (continued)

2. RENEWABLE NATURAL GAS TESTING

Pre-injection testing and periodic testing will be conducted according to the detailed provisions in the Agreement. The Applicant's RNG will not be accepted into the Utility's Distribution Pipeline System without successfully meeting all pre-injection requirements.

- i. The Utility will collect samples at the interconnection point. The Applicant will collect samples upstream of the Utility meter. Samples will be analyzed by independent certified third party laboratories. Retesting shall be allowed to verify and validate the results. The cost of retesting shall be borne by the entity requesting the retest.
- ii. This provision does not prohibit the Utility from engaging in discretionary gas or facility testing on its system. The Applicant will not be financially responsible for Utility discretionary testing.

<p>Issued: December 31, 2018</p> <p>Effective: January 1, 2019</p> <p>Advice Letter No.:</p>	<p>Issued by Justin Lee Brown Senior Vice President</p>	
--	---	--

N
N

Schedule No. SG-RNG/NG-RNG

BIOGAS AND RENEWABLE NATURAL GAS SERVICE
(Continued)

RENEWABLE NATURAL GAS SERVICE (continued)

3. ACCESS TO RENEWABLE NATURAL GAS INTERCONNECTION POINTS

Upon agreement(s) between Applicant and Utility, Utility shall provide the Applicant(s) access to an interconnection point to the Utility's Distribution Pipeline System for the purpose of physically interconnecting with the Utility's distribution facilities and the delivery of RNG into the Utility's Distribution Pipeline System, according to the provisions of agreement(s) between the Applicant and the Utility and this tariff. Nothing in this provision shall be interpreted as creating a requirement that the Utility purchase, transport or distribute any RNG. Further, nothing in this provision shall be interpreted as requiring Utility to enter a written agreement with Applicant(s) to provide access to Utility's Distribution Pipeline System for RNG.

Interconnection Terms of Access

The Utility will perform interconnection-related work under the following conditions:

- a. The interconnection and physical flow of the RNG can be received into the Utility's existing facilities in so far that it does not jeopardize the integrity or normal operation of the Utility's Distribution Pipeline System and without adversely affecting service to the Utility's end-use customers. The specific interconnection point(s) will be determined by the Utility and identified in the Agreement(s).

<p>Issued: December 31, 2018</p> <p>Effective: January 1, 2019</p> <p>Advice Letter No.:</p>	<p>Issued by Justin Lee Brown Senior Vice President</p>	
--	---	--

Schedule No. SG-RNG/NG-RNG

BIOGAS AND RENEWABLE NATURAL GAS SERVICE
(Continued)

RENEWABLE NATURAL GAS SERVICE (continued)

3. ACCESS TO RENEWABLE NATURAL GAS INTERCONNECTION POINTS
(Continued)

- i. Interconnection Terms of Access (continued)
 - b. The maximum capacity for RNG received into the Utility's Distribution Pipeline System at the interconnection point(s) will be determined by the size of the facilities and the Utility's ability to redeliver the RNG downstream of the interconnection point(s), including the metering and odorization capacities. The maximum capacity for the RNG received into the Utility's Distribution Pipeline System at any specific interconnection point is not the capacity of the Utility's Biogas cleaning and upgrading facilities or the Utility's pipeline system to transport gas away from that interconnection point and is not, nor is it intended to be, any commitment by the Utility of any cleaning and upgrading capacity or takeaway capacity.
 - c. The available capacity for an Applicant to deliver RNG into the Utility's Distribution Pipeline System may, on any day, be affected by physical flows from the RNG supplier or by other interconnection points, physical pipeline capacity, daily pipeline operating conditions, and end-use demand on the Utility's Distribution Pipeline System.
 - d. The Utility shall be responsible for the Utility's engineering study to determine the Utility's take away capacity and the ability to receive RNG into the Utility's Distribution Pipeline System.
 - e. The Applicant(s) shall be responsible for and shall pay the other costs associated with the evaluation, design and construction of facilities to provide RNG. Such costs may include, but are not limited to: engineering studies, engineering, construction, materials, equipment and pipeline capacity. The Utility shall own and operate all facilities on the Utility's side of the interconnection point(s).

<p>Issued: December 31, 2018</p> <p>Effective: January 1, 2019</p> <p>Advice Letter No.:</p>	<p>Issued by Justin Lee Brown Senior Vice President</p>	
--	---	--

Schedule No. SG-RNG/NG-RNG

BIOGAS AND RENEWABLE NATURAL GAS SERVICE
(Continued)

RENEWABLE NATURAL GAS SERVICE (continued)

3. ACCESS TO RENEWABLE NATURAL GAS INTERCONNECTION POINTS
(Continued)

i. Interconnection Terms of Access (continued)

- f. The Applicant(s) shall execute a standard agreement(s), which shall contain a description of all work to be performed by the Utility, as well as the costs and payment terms to be made by the Applicant(s) to the Utility.
- g. The Applicant(s), at its expense, shall obtain all land rights, easements, permits and/or other authorizations, and shall design and construct the piping, valves, filter separators, and other equipment that is required at the interconnection point(s) to effectuate deliveries of the RNG to the Utility, in accordance with sound and prudent industry practices and complies with all applicable laws, rules, and regulations of any authority having jurisdiction.
- h. The Applicant(s) shall install and maintain in good working condition the necessary pressure regulation or compression and flow equipment to effectuate delivery of RNG to the interconnection point(s) at or above the prevailing pressure required by the Utility's Distribution Pipeline System. The Applicant's equipment shall be designed and installed to protect the Utility's Distribution Pipeline System from exposure to pressures more than the Utility's Distribution Pipeline System maximum operating pressure at the interconnection point(s).
- i. The Applicant(s) and the Utility shall execute an operating and/or other necessary agreement(s) prior to the final interconnection and the commencement of RNG flowing into the Utility's Distribution Pipeline System.

<p>Issued: December 31, 2018 Effective: January 1, 2019 Advice Letter No.:</p>	<p>Issued by Justin Lee Brown Senior Vice President</p>	
--	---	--

Schedule No. SG-RNG/NG-RNG

BIOGAS AND RENEWABLE NATURAL GAS SERVICE
(Continued)

PROHIBITION OF BIOGAS AND RENEWABLE NATURAL GAS FROM HAZARDOUS WASTE FACILITIES

1. Biogas and RNG from hazardous waste facilities, including landfills permitted by the Nevada Department of Environmental Protection, will not be gathered, processed, cleaned, upgraded, purchased, accepted or transported on Utility-Owned Biogas Facilities or Utility's Distribution Pipeline System.
2. Before an Applicant can interconnect with the Utility's Distribution Pipeline System, the Biogas and/or RNG supplier must demonstrate that the Biogas used in the process of creating the RNG was not collected from a facility or landfill designated as a hazardous waste facility.

<p>Issued: December 31, 2018 Effective: January 1, 2019 Advice Letter No.:</p>	<p>Issued by Justin Lee Brown Senior Vice President</p>	
--	---	--

N
N

Schedule No. SG-RNG/NG-RNG

BIOGAS AND RENEWABLE NATURAL GAS SERVICE
(Continued)

DEFINITIONS

Biogas:	A mixture of methane, carbon dioxide, and other constituents that is produced by the anaerobic digestion with anaerobic bacteria or fermentation of biodegradable materials such as biomass (manure, sewage, green waste, plant material, crops, and municipal waste or landfills).
Hazardous Waste:	For the purposes of this Schedule, hazardous waste shall have the same meaning as provided in Nevada Revised Statutes §459.430.
Hazardous Waste Facility:	For the purposes of this Schedule, hazardous waste facility shall refer to all contiguous land and structures, other appurtenances and improvements on the land used for treating, storing or disposing of hazardous waste.
Health and Pipeline Integrity Protective Constituents:	Any constituent that may cause a premature pipeline failure or exceed the manufacturer's specified carrying constituents.
Interconnection Point:	Place at which Applicant's facilities connect with Company facilities.
Merchantability:	The ability to purchase, sell or market Biogas or Renewable Natural Gas.
Renewable Natural Gas (RNG):	A biogas which has been upgraded to pipeline quality gas by increasing the percentage of methane in Biogas by removing carbon dioxide and other trace components and adding a warning odorant. When upgraded, it is possible to distribute via the existing natural gas pipeline system.
Utility-Owned Biogas Facilities:	Facilities used to gather Biogas or upgrade Biogas to pipeline quality gas that is owned and operated by Utility, including but not limited to gathering pipelines, Biogas cleaning systems and Biogas upgrading systems.
Utility's Distribution Pipeline System:	The Utility-owned facilities used to provide natural gas service to the Utility's customers.

<p>Issued: December 31, 2018</p> <p>Effective: January 1, 2019</p> <p>Advice Letter No.:</p>	<p>Issued by Justin Lee Brown Senior Vice President</p>	
--	---	--

SCHEDULE NO. SG-G5
GENERAL GAS SERVICE - 5

APPLICABILITY

Applicable to customers whose average monthly requirements on an annual basis are 1,000,000 therms or greater and whose natural gas use during the Company's winter peak months of December through February is less than fifteen (15) percent of their annual usage.

TERRITORY

Throughout the Company's certificated Southern Nevada Service Areas, except as may hereafter be provided.

RATES

The demand charge, commodity charge and Basic Service Charge are set forth in the currently effective Statement of Rates of this Nevada Gas Tariff and are incorporated herein by reference.

For customers electing to receive sales service under this schedule, the Base Tariff Energy Rate (BTER) of the customer's sales rate will be determined in accordance with Special Condition No. 4 of this schedule.

The monthly demand charge shall be the product of the demand charge rate multiplied by the customer's billing determinant. The billing determinant shall be equal to the customer's highest monthly throughput during the most recent 12 month period, ending the month prior to the current billing period. Reductions in the customer's billing demand will be limited to no greater than 20 percent during any 12 month period ending with the current billing period. For new customers, the initial billing determinant shall be calculated by multiplying the customer's estimated average daily use by the number of days in the billing period.

The minimum charge per month is the sum of the Basic Service Charge and the demand charge.

<p>Issued: October 2, 2020</p> <p>Effective: October 7, 2020</p> <p>Advice Letter No.:</p>	<p>Issued by Justin Lee Brown Senior Vice President</p>	
--	---	--

SCHEDULE NO. SG-G5
GENERAL GAS SERVICE - 5
(Continued)

LATE CHARGE

The monthly bill is due and payable as of the date of presentation. Included in the bill will be a late charge of five percent on the first \$200 of the monthly bill, plus two percent of any balance above \$200, which will be imposed if payment is not received by the next month's billing.

SPECIAL CONDITIONS

1. A service agreement specifying the customer's volumetric requirements and curtailment priority as defined in NAC 704.501 may be required under this schedule.
2. To receive sales service under this schedule, customers must make a three-year commitment to sales service.
3. Customers under this schedule may elect transportation service after providing an 18 month notification; however, customers with an active sales service agreement can return to transportation service only at the conclusion of their sales service agreement after providing at least 18 months notice.

Customers who switch to transportation service without providing proper notice will be assessed an exit fee to prevent the shifting of any costs to its remaining sales customers, if the Company determines there are such costs associated with the customer's change in service.

<p>Issued: October 2, 2020</p> <p>Effective: October 7, 2020</p> <p>Advice Letter No.:</p>	<p>Issued by Justin Lee Brown Senior Vice President</p>	
--	---	--

SCHEDULE NO. SG-G5
GENERAL GAS SERVICE - 5
(Continued)

SPECIAL CONDITIONS (Continued)

4. The Base Tariff Energy Rate (BTER) of the customer's sales rate will be the higher of the following charges:

- (i) The BTER of the Currently Effective Tariff Rate; or
- (ii) The monthly weighted average cost of gas, including an assessment for interstate capacity costs, incurred by the Company.

For customers switching from transportation service the customer's sales rate will be adjusted to exclude the Deferred Energy Account Adjustment (DEAA) for the initial 12 month sales period. After the conclusion of the initial twelve 12 month sales period, the customer shall be billed the Currently Effective DEAA Tariff Rate.

BASE TARIFF ENERGY RATE (BTER) AND DEFERRED ENERGY ACCOUNT ADJUSTMENT (DEAA)

The rates specified for this schedule are subject to increases or decreases in the cost of purchased gas in accordance with those provisions set forth in Chapter 704 of the NAC.

GENERAL TERMS AND CONDITIONS

Except as qualified in this schedule, all of the General Terms and Conditions are applicable to this schedule and are hereby made a part hereof.

<p>Issued: October 2, 2020</p> <p>Effective: October 7, 2020</p> <p>Advice Letter No.:</p>	<p>Issued by Justin Lee Brown Senior Vice President</p>	
--	---	--

SCHEDULE NO. SG-G6
GENERAL GAS SERVICE - 6

APPLICABILITY

Applicable to customers whose average monthly requirements on an annual basis are 1,000,000 therms or greater and whose natural gas use during the Company's winter peak months of December through February is equal to or greater than fifteen (15) percent of their annual usage.

TERRITORY

Throughout the Company's certificated Southern Nevada Service Areas, except as may hereafter be provided.

RATES

The demand charge, commodity charge and Basic Service Charge are set forth in the currently effective Statement of Rates of this Nevada Gas Tariff and are incorporated herein by reference.

For customers electing to receive sales service under this schedule, the Base Tariff Energy Rate (BTER) of the customer's sales rate will be determined in accordance with Special Condition No. 4 of this schedule.

The monthly demand charge shall be the product of the demand charge rate multiplied by the customer's billing determinant. The billing determinant shall be equal to the customer's highest monthly throughput during the most recent 12 month period, ending the month prior to the current billing period. Reductions in the customer's billing demand will be limited to no greater than 20 percent during any 12 month period ending with the current billing period. For new customers, the initial billing determinant shall be calculated by multiplying the customer's estimated average daily use by the number of days in the billing period.

The minimum charge per month is the sum of the Basic Service Charge and the demand charge.

<p>Issued: April 1, 2022</p> <p>Effective: April 1, 2022</p> <p>Advice Letter No.:</p>	<p style="text-align: center;">Issued by Amy L. Timperley Vice President</p>	
--	--	--

C

T
T

SCHEDULE NO. SG-G6
GENERAL GAS SERVICE - 6
(Continued)

LATE CHARGE

The monthly bill is due and payable as of the date of presentation. Included in the bill will be a late charge of five percent on the first \$200 of the monthly bill, plus two percent of any balance above \$200, which will be imposed if payment is not received by the next month's billing.

SPECIAL CONDITIONS

1. A service agreement specifying the customer's volumetric requirements and curtailment priority as defined in NAC 704.501 may be required under this schedule.
2. To receive sales service under this schedule, customers must make a three-year commitment to sales service.
3. Customers under this schedule may elect transportation service after providing an 18 month notification; however, customers with an active sales service agreement can return to transportation service only at the conclusion of their sales service agreement after providing at least 18 months notice.

Customers who switch to transportation service without providing proper notice will be assessed an exit fee to prevent the shifting of any costs to its remaining sales customers, if the Company determines there are such costs associated with the customer's change in service.

<p>Issued: October 2, 2020</p> <p>Effective: October 7, 2020</p> <p>Advice Letter No.:</p>	<p>Issued by Justin Lee Brown Senior Vice President</p>	
--	---	--

SCHEDULE NO. SG-G6
GENERAL GAS SERVICE - 6
(Continued)

SPECIAL CONDITIONS (Continued)

4. The Base Tariff Energy Rate (BTER) of the customer's sales rate will be the higher of the following charges:

- (i) The BTER of the Currently Effective Tariff Rate; or
- (ii) The monthly weighted average cost of gas, including an assessment for interstate capacity costs, incurred by the Company.

For customers switching from transportation service the customer's sales rate will be adjusted to exclude the Deferred Energy Account Adjustment (DEAA) for the initial 12 month sales period. After the conclusion of the initial twelve 12 month sales period, the customer shall be billed the Currently Effective DEAA Tariff Rate.

BASE TARIFF ENERGY RATE (BTER) AND DEFERRED ENERGY ACCOUNT ADJUSTMENT (DEAA)

The rates specified for this schedule are subject to increases or decreases in the cost of purchased gas in accordance with those provisions set forth in Chapter 704 of the NAC.

GENERAL TERMS AND CONDITIONS

Except as qualified in this schedule, all of the General Terms and Conditions are applicable to this schedule and are hereby made a part hereof.

<p>Issued: October 2, 2020</p> <p>Effective: October 7, 2020</p> <p>Advice Letter No.:</p>	<p>Issued by Justin Lee Brown Senior Vice President</p>	
--	---	--

SOUTHWEST GAS CORPORATION
P.O. Box 98510
Las Vegas, Nevada 89193-8510
Nevada Gas Tariff No. 7

Canceling 3rd Revised P.U.C.N. Sheet No. 53P
2nd Revised P.U.C.N. Sheet No. 53P

HELD FOR FUTURE USE

D/T

Issued:
April 1, 2022

Effective:
April 1, 2022

Advice Letter No.:

Issued by
Amy L. Timperley
Vice President

D

T
T

SOUTHWEST GAS CORPORATION
P.O. Box 98510
Las Vegas, Nevada 89193-8510
Nevada Gas Tariff No. 7

Canceling 1st Revised P.U.C.N. Sheet No. 53Q
Original P.U.C.N. Sheet No. 53Q

HELD FOR FUTURE USE

D/T

D

<p>Issued: April 1, 2022</p> <p>Effective: April 1, 2022</p> <p>Advice Letter No.:</p>	<p>Issued by Amy L. Timperley Vice President</p>	
--	--	--

T
T

SOUTHWEST GAS CORPORATION
P.O. Box 98510
Las Vegas, Nevada 89193-8510
Nevada Gas Tariff No. 7

Canceling 1st Revised P.U.C.N. Sheet No. 53R
Original P.U.C.N. Sheet No. 53R

HELD FOR FUTURE USE

<p>Issued: April 1, 2022</p> <p>Effective: April 1, 2022</p> <p>Advice Letter No.:</p>	<p>Issued by Amy L. Timperley Vice President</p>	
--	--	--

D/T

D

T
T

SCHEDULE NO. NG-G5
GENERAL GAS SERVICE – 5

APPLICABILITY

Applicable to customers whose average monthly requirements on an annual basis are 1,000,000 therms or greater.

TERRITORY

Throughout the Company's certificated Northern Nevada Service Areas, except as may hereafter be provided.

RATES

The demand charge, commodity charge and Basic Service Charge are set forth in the currently effective Statement of Rates of this Nevada Gas Tariff and are incorporated herein by reference.

To receive sales service under this schedule, the Base Tariff Energy Rate (BTER) of the customer's sales rate will be determined in accordance with Special Condition No. 4 of this schedule.

The monthly demand charge shall be the product of the demand charge rate multiplied by the customer's billing determinant. The billing determinant shall be equal to the customer's highest monthly throughput during the most recent 12 month period, ending the month prior to the current billing period. Reductions in the customer's billing demand will be limited to no greater than 20 percent during any 12 month period ending with the current billing period.

The minimum charge per month is the sum of the Basic Service Charge and the demand charge.

<p>Issued: October 2, 2020</p> <p>Effective: October 7, 2020</p> <p>Advice Letter No.:</p>	<p>Issued by Justin Lee Brown Senior Vice President</p>	
--	---	--

SCHEDULE NO. NG-G5
GENERAL GAS SERVICE - 5
(Continued)

LATE CHARGE

The monthly bill is due and payable as of the date of presentation. Included in the bill will be a late charge of five percent on the first \$200 of the monthly bill, plus two percent of any balance above \$200, which will be imposed if payment is not received by the next month's billing.

SPECIAL CONDITIONS

1. A service agreement specifying the customer's volumetric requirements and curtailment priority as defined in NAC 704.501 may be required under this schedule.
2. To receive sales service under this schedule, the customer must make a three-year commitment to sales service.
3. The customer under this schedule may elect transportation service after providing an 18 month notification; however, customers with an active sales service agreement can return to transportation service only at the conclusion of their sales service agreement after providing at least 18 months notice.

If the customer switches to transportation service without providing proper notice an exit fee will be assessed to prevent the shifting of any costs to its remaining sales customers, if the Company determines there are such costs associated with the customer's change in service.

<p>Issued: October 2, 2020</p> <p>Effective: October 7, 2020</p> <p>Advice Letter No.:</p>	<p>Issued by Justin Lee Brown Senior Vice President</p>	
--	---	--

SCHEDULE NO. NG-G5
GENERAL GAS SERVICE - 5
(Continued)

SPECIAL CONDITIONS (Continued)

4. The Base Tariff Energy Rate (BTER) of the customer's sales rate will be the higher of the following charges:

- (i) The BTER of the Currently Effective Tariff Rate; or
- (ii) The monthly weighted average cost of gas, including an assessment for interstate capacity costs, incurred by the Company.

For customers switching from transportation service the customer's sales rate will be adjusted to exclude the Deferred Energy Account Adjustment (DEAA) for the initial 12 month sales period. After the conclusion of the initial twelve 12 month sales period, the customer shall be billed the Currently Effective DEAA Tariff Rate.

BASE TARIFF ENERGY RATE (BTER) AND DEFERRED ENERGY ACCOUNT ADJUSTMENT (DEAA)

The rates specified for this schedule are subject to increases or decreases in the cost of purchased gas in accordance with those provisions set forth in Chapter 704 of the NAC.

GENERAL TERMS AND CONDITIONS

Except as qualified in this schedule, all of the General Terms and Conditions are applicable to this schedule and are hereby made a part hereof.

<p>Issued: October 2, 2020</p> <p>Effective: October 7, 2020</p> <p>Advice Letter No.:</p>	<p>Issued by Justin Lee Brown Senior Vice President</p>	
--	---	--

SCHEDULE NO. ST-1/NT-1

TRANSPORTATION OF CUSTOMER-SECURED NATURAL GAS

1. AVAILABILITY

This schedule is available to any customer for transportation of natural gas by the Company from any existing interconnection between the Company and its upstream pipeline transporters, herein called Receipt Point to the Delivery Point(s) on the Company's system under the following conditions:

- 1.1 The Company has available capacity to render the requested service without construction of any additional facilities, except as provided by Section 8 hereof;
- 1.2 This transportation schedule is available for use by customers that qualify for service per either (a), (b), (c) or (d) below:
 - a. Except for customers otherwise served under Schedule Nos. SG-AC/NG-AC, SG-WP/NG-WP, or SG-CNG/NG-CNG, the transportation quantity shall average, on an annual basis, not less than 500 therms per day at one of the customer's premises.
 - b. Projected transportation quantities for customers otherwise served under Schedule No. SG-CNG/NG-CNG shall not be less than 50,000 therms annually at one of the customer's premises.
 - c. Projected transportation quantities for seasonal customers otherwise served under Schedule Nos. SG-AC/NG-AC or SG-WP/NG-WP shall not be less than 500 therms per day at one of the customer's premises during the months of May through October.
 - d. Customers with multiple meters from the same class of service at a single premise, including subcategories of general service, may combine such meters to meet the minimum quantity requirements specified in (a), (b) or (c) above to qualify for transportation service.

<p>Issued: April 30, 2019</p> <p>Effective: April 15, 2019</p> <p>Advice Letter No.: 511</p>	<p>Issued by Justin Lee Brown Senior Vice President</p>	
---	---	--

SCHEDULE NO. ST-1/NT-1

TRANSPORTATION OF CUSTOMER-SECURED NATURAL GAS
(Continued)

1. AVAILABILITY *(Continued)*

1.3 The customer and the Company have executed a service agreement for service under this schedule. A single service agreement may provide for service to any or all the customer's separate premises, if all the premises are under common ownership. Each premise must individually qualify for transportation service.

1.4 Sales Service Election. Existing transportation customers are required to notify the Company if they desire to elect sales service. The election must be submitted to the Company no later than April 1 of each year for sales service commencing the following November 1.

2. APPLICABILITY AND CHARACTER OF SERVICE

This schedule shall apply to gas transported by the Company for the customer pursuant to the executed service agreement.

- 2.1 The basic transportation service rendered under this schedule shall consist of:
- a. The receipt by the Company for the account of the customer of the customer's gas at the Receipt Point(s);
 - b. The transportation of gas through the Company's system for the account of the customer; and
 - c. The delivery of gas after transportation by the Company for the account of the customer at the Delivery Point(s).

<p>Issued: April 30, 2019</p> <p>Effective: April 15, 2019</p> <p>Advice Letter No.: 511</p>	<p>Issued by Justin Lee Brown Senior Vice President</p>	
---	---	--

SCHEDULE NO. ST-1/NT-1

TRANSPORTATION OF CUSTOMER-SECURED NATURAL GAS
(Continued)

2. APPLICABILITY AND CHARACTER OF SERVICE (Continued)

2.2 The Company may curtail or interrupt service as defined by Section 5 of this schedule or by Rule No. 8 of this Nevada Gas Tariff. In the event of curtailment or interruption, the Company shall provide service as follows:

- a. The Company shall provide the customer with as much notice as is practical of any curtailment or interruption of service;
- b. The Company may, to the extent feasible, continue to receive the customer's gas at the Receipt Point(s) on a scheduled basis during the period of curtailment or interruption and shall, to the extent feasible, redeliver such gas at the Delivery Point(s). For the period of curtailment or interruption, the Company may waive any payments that may otherwise be due pursuant to Section 7 hereof.

<p>Issued: April 30, 2019</p> <p>Effective: April 15, 2019</p> <p>Advice Letter No.: 511</p>	<p>Issued by Justin Lee Brown Senior Vice President</p>	
--	---	--

SCHEDULE NO. ST-1/NT-1

TRANSPORTATION OF CUSTOMER-SECURED NATURAL GAS
(Continued)

2. APPLICABILITY AND CHARACTER OF SERVICE *(Continued)*

2.2 *(Continued)*

c. Alternate fuel capable customers with an average annual usage of greater than 1,000 therms per day served under this schedule may be asked by the Company to voluntarily switch to their alternate fuel source. If the Company requests that any such customer served hereunder switch to its alternate fuel source in order to continue service to a lower priority (numerically higher priority number) customer, the Company shall credit to such customer (1) the cost of any gas diverted for use by lower priority customers, and (2) the incremental cost of the alternate fuel, i.e., the difference between the actual cost of using the alternate fuel and the actual cost of natural gas purchased by the customer for transportation under this schedule. Such credit shall be applied to the Company's next scheduled billing after customer has furnished adequate proof to the Company concerning replacement quantities and incremental costs. The Company reserves the right to verify alternate fuel consumption and cost and to quantify the associated reduction in deliveries of natural gas for the period requested by the Company. This provision shall not apply when higher priority (numerically lower priority number) customers are being curtailed or when curtailment quantities exceed the aggregate quantities displaced by alternate fuel under this provision.

2.3 Gas transported under this schedule shall be for use only by the customer, except for customers who would otherwise be served under Schedule No. SG-CNG/NG-CNG. Service under the provisions of this schedule shall not constitute the dedication of the Company's pipeline system or any portion thereof to the customer.

<p>Issued: April 30, 2019</p> <p>Effective: April 15, 2019</p> <p>Advice Letter No.: 511</p>	<p>Issued by Justin Lee Brown Senior Vice President</p>	
---	---	--

SCHEDULE NO. ST-1/NT-1

TRANSPORTATION OF CUSTOMER-SECURED NATURAL GAS
(Continued)

3. RATES

3.1 The customer shall pay the Company monthly the sum of the following charges.

- a. Basic Service Charge. The Basic Service Charge as set forth in the Statement of Rates of this Nevada Gas Tariff for each meter included in the transportation service agreement.
- b. Volumetric Charges. The margin component of the commodity charge, the Renewable Energy Program Rate, plus the Conservation and Energy Efficiency rate applicable to transportation customers per term as set forth in the Statement of Rates of this Nevada Gas Tariff for each meter included in the transportation service agreement, plus an amount for distribution system shrinkage as defined in Rule No. 1 and set forth in the Statement of Rates of this Nevada Gas Tariff. The amount collected for distribution system shrinkage shall be recorded in the Deferred Energy Account.
- c. Demand Charge. The monthly demand charge, if applicable, shall be the product of the demand charge rate set forth on the Statement of Rates of this Nevada Gas Tariff, multiplied by the customer's billing determinant. The billing determinant shall be equal to the customer's highest monthly throughput during the most recent 12 month period, ending prior to the current billing period. For new customers, the initial billing determinant shall be calculated by multiplying the customer's estimated average daily use by 30 days.
- d. Transportation Service Charge. A monthly charge per individually qualifying premise as set forth in the Statement of Rates of this Nevada Gas Tariff.

<p>Issued: December 31, 2018</p> <p>Effective: January 1, 2019</p> <p>Advice Letter No.:</p>	<p>Issued by Justin Lee Brown Senior Vice President</p>	
--	---	--

SCHEDULE NO. ST-1/NT-1

TRANSPORTATION OF CUSTOMER-SECURED NATURAL GAS
(Continued)

3. RATES *(Continued)*

3.1 *(Continued)*

- e. Deferred Energy Account Adjustment. For customers converting from sales service in accordance with Section 1.4 hereof an additional amount equal to the currently effective Deferred Energy Account Adjustment will be assessed for a period of 12 months.
- f. Any applicable imbalance charges as specified in Section 7 hereof.
- g. Anti-Bypass Rate Adjustment. This provision is only available to customers who qualify for service under Schedule No. SG-G5, SG-G6, or NG-G5. To avert bypass, the Company may execute a discounted rate contract with the customer that provides for rates within the maximum and minimum rates in the customer's applicable rate schedule. If the customer seeks methods, terms, conditions, or rates that are negotiated or differ from the applicable rate schedule to avert bypass, the Company may execute a contract for special services with the customer. Any discounted rate contract or contract for special services must conform to and be approved pursuant to NAC 704.516 to 704.528.

The Company may adjust from time to time the applicable unit transportation rates to customers whose requirements may be served by other natural gas pipelines provided.

As a condition precedent to qualifying for an Anti-Bypass Rate Adjustment, the utility and the customer shall jointly file a discounted rate contract with the Commission at least sixty (60) days prior to the customer taking service pursuant to the discounted rate contract and simultaneously serve the Regulatory Operations Staff and the Bureau of Consumer Protection with a copy of the application.

<p>Issued: April 1, 2022</p> <p>Effective: April 1, 2022</p> <p>Advice Letter No.:</p>	<p>Issued by Amy L. Timperley Vice President</p>	
--	--	--

C
C
T
T

SCHEDULE NO. ST-1/NT-1

TRANSPORTATION OF CUSTOMER-SECURED NATURAL GAS
(Continued)

3. RATES (Continued)

3.1 (Continued)

g. Anti-Bypass Rate Adjustment (Continued)

If a protest is filed, the Commission will schedule a hearing to determine whether the protest is valid and will issue an order within 150 days of the filing date of the application. If no protest is filed, the discounted rate contract becomes effective as provided in the application.

The joint filing must include evidence demonstrating the customer can bypass the facilities of the Company and that bypass is feasible physically, economically, operationally and that bypass is imminent. The customer must provide the foregoing evidence to the Company before the Company and the customer jointly file an application for approval of a discounted rate contract.

When the Company adjusts rates from the applicable tariff rate to avert customer bypass, the margin component set forth in Section 3.1.b or 3.1.c, or both, will be adjusted, provided however, that such rates shall not exceed or be less than the maximum and minimum rates for the customer's applicable rate schedule as set forth in the Company's tariff. If the Company seeks to charge a rate that is outside of the limits established for the applicable rate schedule or seeks terms and conditions of service outside those set forth in the applicable rate schedule, the Company shall file with the Commission an application for the approval of a contract for special services between the Company and the customer. The contract for special services must specify the method, terms, conditions and rates by which services are rendered to the customer. Service shall not be provided pursuant to a contract for special services until the contract is approved by the Commission.

<p>Issued: April 1, 2022</p> <p>Effective: April 1, 2022</p> <p>Advice Letter No.:</p>	<p>Issued by Amy L. Timperley Vice President</p>	
--	--	--

SCHEDULE NO. ST-1/NT-1

TRANSPORTATION OF CUSTOMER-SECURED NATURAL GAS
(Continued)

3. RATES *(Continued)*

3.1 *(Continued)*

h. Alternate Fuel Capability Rate Adjustment. The Company may adjust from time to time the applicable unit transportation rates to customers whose requirements may be served by alternate fuels. As a condition precedent to qualifying for an Alternate Fuel Capability Rate Adjustment, the customer must have and maintain adequate alternate fuel standby facilities of equivalent capacity to those natural gas facilities served hereunder. These facilities are subject to the Company's inspection and verification of operating capacity and capability. When the Company adjusts rates from the maximum applicable rate to alternate fuel capable customers, the margin component set forth in Section 3.1.b or 3.1.c, or both, will be reduced.

In addition to the Basic Service Charge, transportation service charge, demand charge, volumetric charges and any applicable imbalance charges pursuant to Section 7 herein, the Company shall include as a surcharge on the customer's bill any charges from upstream pipeline transporters or suppliers which have been incurred by the Company because of the transportation service rendered for the customer under this schedule.

- 3.2 Any transportation customer being served under this schedule may elect to switch to sales service in accordance with Section 1.4 under either Schedule No. SG-AS/NG-AS or their otherwise applicable gas sales schedule.
- 3.3 Excluding imbalance charges, all rates and charges described herein shall apply by meter to each meter reflected in the customer's service agreement.
- 3.4 The charges specified for this schedule are subject to adjustment for the applicable proportionate part of any taxes, assessments or governmental impositions assessed on the Company.

<p>Issued: April 30, 2019</p> <p>Effective: April 15, 2019</p> <p>Advice Letter No.: 511</p>	<p>Issued by Justin Lee Brown Senior Vice President</p>	
---	---	--

SCHEDULE NO. ST-1/NT-1

TRANSPORTATION OF CUSTOMER-SECURED NATURAL GAS
(Continued)

4. MINIMUM CHARGE

The minimum charge per month is the Basic Service Charge, the transportation service charge and the demand charge, if applicable.

5. FORCE MAJEURE

5.1. Relief From Liability. Neither party shall be liable in damages to the other on account of "force majeure" occasioned by any act, omission or circumstances occasioned by or in consequence of any act of God, strikes, insurrections, riots, epidemics, landslides, lightning, earthquakes, fires, storms, floods, washouts, arrests and restraints of rulers and people, civil disturbances, explosions, breakage or accident to machinery or lines of pipe, depletion of or temporary failure of gas supply, the binding order of any court or governmental authority which has been resisted in good faith by all reasonable legal means, and any other cause, whether of the kind herein enumerated or not, and not within the control of the party claiming suspension and which by the exercise of due diligence such party is unable to prevent or overcome. Failure to settle or prevent any strikes or other controversy with employees or with anyone purporting or seeking to represent employees shall not be a matter within the control of the party claiming suspension.

5.2. Liabilities Not Relieved. Neither the customer nor the Company shall be relieved from liability in the event of its concurring negligence or failure on its part to use due diligence to remedy the force majeure and remove the cause with all reasonable dispatch, nor shall such causes or contingencies affecting performance of any agreement relieve either party from its obligations to make payments when due in respect of gas theretofore delivered.

<p>Issued: April 30, 2019</p> <p>Effective: April 15, 2019</p> <p>Advice Letter No.: 511</p>	<p>Issued by Justin Lee Brown Senior Vice President</p>	
--	---	--

SCHEDULE NO. ST-1/NT-1

TRANSPORTATION OF CUSTOMER-SECURED NATURAL GAS
(Continued)

6. OPERATING PROCEDURES

6.1 Nominating and Scheduling of Gas Receipts and Deliveries: For nominations made directly to the upstream interstate pipelines, North American Energy Standards Board (NAESB) guidelines will be followed regarding nominating, confirming and scheduling gas receipts and deliveries as they may be revised by the Federal Energy Regulatory Commission (FERC) from time to time. The customer shall be responsible for contacting the upstream interstate pipeline(s) to arrange for the nominating and scheduling of receipts and deliveries. However, the customer may designate one party to serve as its Agent for such purpose. The Company and upstream interstate pipeline(s) require that specific information be provided to successfully process each nomination. It is the customer's or their Agent's responsibility to satisfy the pipeline's information requirements.

For nominations made to the Company, the customer or Agent must provide their nomination(s) to the Company via a Company-approved method no later than the nomination deadlines set forth below:

Cycle 1 (Timely Nominations)	11:00a.m.	Pacific Clock Time on the prior flow day.	T C/T
Cycle 2 (Evening Nominations)	4:00 p.m.	Pacific Clock Time on the prior flow day.	T C/T
Cycle 3 (Intraday Nominations)	8:00 a.m.	Pacific Clock Time on the flow day.	T C/T
Cycle 4 (Intraday Nominations)	12:30 p.m.	Pacific Clock Time on the flow day.	T C/T
Cycle 5 (Intraday Nominations)	5:00 p.m.	Pacific Clock Time on the flow day.	T N

<p>Issued: December 15, 2015</p> <p>Effective: April 1, 2016</p> <p>Advice Letter No.: 498</p>	<p>Issued by Justin Lee Brown Vice President</p>		T T
---	--	--	--------

SCHEDULE NO. ST-1/NT-1

TRANSPORTATION OF CUSTOMER-SECURED NATURAL GAS
(Continued)

6. OPERATING PROCEDURES (Continued)

6.1. Nominating and Scheduling of Gas Receipts and Deliveries (Continued)

- (a) Customers or their Agents may submit Nominations for multiple days (Standing Nominations), provided such Nominations are within the term of the customer's transportation service agreement. The Company will confirm whether it has sufficient operational capacity to deliver all or a portion of the customer's gas.
- (b) Nominations received after a deadline will be processed for the following cycle with the exception that late Cycle 5 Nominations will not be processed. The Company will confirm the quantities nominated for Cycle 1 (Timely Nominations) through all five cycles, regardless of upstream cuts in scheduled quantities, unless the Company receives a revised Nomination from the responsible party for any subsequent cycle.
- (c) Intraday Nominations will replace existing Standing Nominations only for the duration of the flow day requested.
- (d) Balancing quantities nominated under the provisions of Section 6.9 herein must be separately identified in the Nomination. The Company shall determine and notify the customer if there is sufficient operating flexibility to schedule such quantities. The Company will only accept balancing quantities for Cycle 1 Nominations.

<p>Issued: December 31, 2018</p> <p>Effective: January 1, 2019</p> <p>Advice Letter No.:</p>	<p>Issued by Justin Lee Brown Senior Vice President</p>	
--	---	--

SCHEDULE NO. ST-1/NT-1

TRANSPORTATION OF CUSTOMER-SECURED NATURAL GAS
(Continued)

6. OPERATING PROCEDURES (Continued)

6.1. Nominating and Scheduling of Gas Receipts and Deliveries (Continued)

(e) Nominations for multiple customers must specify the quantity of gas to be scheduled at each of the Company's receipt points with its upstream interstate pipeline(s). The customer or Agent must specify, prior to the flow day, the method to be used by the Company for allocating imbalances among individual customers. If the allocation method is not specified prior to the flow day, the Company will allocate any imbalances pro rata from the Cycle 1 Nomination.

6.2 Limitation Upon the Company's Daily Transportation Obligations. Customer shall cause deliveries into the Company's system quantities to be transported hereunder to be made at approximately a uniform daily rate. On any operating day, the Company may refuse to accept quantities of gas that result in fluctuations more than ten percent (10%) from the quantities transported during the previous operating day. Fluctuations more than ten percent (10%) shall only be allowed if prior approval has been obtained from the Company's gas scheduling department.

6.3 Records of Scheduled Quantities

- a. The Company shall keep accurate records of the quantities of gas scheduled for transportation and any imbalances, which records shall be made available to the customer at its request. If the customer's gas is commingled with other gas at the Receipt Point(s) or at the Delivery Point(s), the scheduling arrangements and the Company's records shall include procedures for the division of the total quantity at such points.
- b. On any day when a customer's metered quantity differs from the sum of the customer's scheduled transportation quantity and approved imbalance adjustment, the difference shall be balanced subject to Sections 6.9 and 7 herein.

<p>Issued: April 30, 2019</p> <p>Effective: April 15, 2019</p> <p>Advice Letter No.: 511</p>	<p>Issued by Justin Lee Brown Senior Vice President</p>	
--	---	--

C/R
C/R
T
T

SCHEDULE NO. ST-1/NT-1

TRANSPORTATION OF CUSTOMER-SECURED NATURAL GAS
(Continued)

6. OPERATING PROCEDURES *(Continued)*

- 6.4 Arrangements Prior to Receipt and After Delivery. It shall be the customer's obligation to make arrangements with other parties for delivery of gas into the Company's system at the Receipt Point(s) and for receipt of gas after transportation to the Delivery Point(s). The customer shall be obligated in such arrangements to require dispatching and operating coordination by such other parties with the Company and access to appropriate charts and records. Such arrangements must be satisfactory to the Company.
- 6.5 Operating Information and Estimates. Upon request of the Company, the customer shall from time to time submit its best estimates of the daily, monthly and annual quantities of gas to be transported, including peak day requirements, together with such other operating data as the Company may require to schedule its operations.
- 6.6 Quantities. All quantities referred to in Section 6 shall be provided as MMBtus (one million BTus).
- 6.7 Deliverability. The Company shall not be liable for its failure to deliver gas when such failure to deliver gas shall be due to unavailability of gas supply or interruption of third party transportation services.
- 6.8 Processing Requests for Transportation Service. Requests for transportation hereunder shall be made by and shall be deemed to be complete upon the customer providing the following information to the Company:
- a. Gas Quantities. The Maximum Daily Quantity applicable to the Receipt Point(s) and the Maximum Daily Quantity applicable to each Delivery Point and estimated total quantities to be received and transported over the delivery period should be stated individually in both Mcfs and MMBtus for each Receipt Point and Delivery Point.

<p>Issued: April 30, 2019</p> <p>Effective: April 15, 2019</p> <p>Advice Letter No.: 511</p>	<p>Issued by Justin Lee Brown Senior Vice President</p>	
---	---	--

SCHEDULE NO. ST-1/NT-1

TRANSPORTATION OF CUSTOMER-SECURED NATURAL GAS
(Continued)

6. OPERATING PROCEDURES *(Continued)*

6.8 Processing Requests for Transportation Service *(Continued)*

- b. Delivery Point(s). Point(s) of delivery by the Company to the customer.
- c. Term of Service.
 - (1) Date service requested to commence; and
 - (2) Date service requested to terminate.
- d. Performance. A letter from the customer certifying that the customer has entered or will enter those arrangements necessary to assure all upstream transportation will be in place prior to the commencement of service under a service agreement. The customer's agent, if any, must be named.

Upon receipt of all the information specified above, the Company shall prepare and tender to the customer for execution a service agreement in the form contained in this Nevada Gas Tariff. If the customer fails to execute the service agreement within 30 days of the date tendered, the customer's request shall be deemed null and void.

<p>Issued: April 30, 2019</p> <p>Effective: April 15, 2019</p> <p>Advice Letter No.: 511</p>	<p>Issued by Justin Lee Brown Senior Vice President</p>	
---	---	--

SCHEDULE NO. ST-1/NT-1

TRANSPORTATION OF CUSTOMER-SECURED NATURAL GAS
(Continued)

6. OPERATING PROCEDURES *(Continued)*

6.9 Balancing. Customers must endeavor to schedule supplies at the Company's Receipt Points that match the customer's daily demands. Balancing of thermally equivalent quantities of gas received and delivered shall be achieved as nearly as feasible daily, considering the customer's right, subject to the Company's approval, to vary receipts and deliveries within specified limits. Imbalances established in excess of the applicable daily, including days the Company has issued an Operational Flow Order (OFO), or monthly operating windows will be subject to imbalance charges as specified in Section 7 herein. If, in the Company's sole good faith judgment, operating conditions permit, and upon request from the customer, the Company may increase the daily operating window. Any imbalance (plus or minus) carried forward, as well as any Company-approved imbalance nomination, shall be considered first through the meter during the next applicable daily or monthly period.

a. Daily Balancing

Customers are provided a Daily Operating Window under which the customer's Daily Imbalance must be within plus or minus ten percent ($\pm 10\%$) of transportation quantities scheduled for burn on that gas day, or 10,000 therms, whichever is greater. The Daily Imbalance defined as the difference between the customer's daily transportation quantities scheduled for burn and the customer's daily metered quantity, including the effect of any adjustment for cycle billing. The Daily Operating Window Percentage is subject to the Company's adjustment depending on upstream pipeline conditions, as well as operation pressures and flow rates on the Company's system pursuant to Section 6.9.c. herein.

<p>Issued: April 30, 2019</p> <p>Effective: April 15, 2019</p> <p>Advice Letter No.: 511</p>	<p>Issued by Justin Lee Brown Senior Vice President</p>	
---	---	--

SCHEDULE NO. ST-1/NT-1

TRANSPORTATION OF CUSTOMER-SECURED NATURAL GAS
(Continued)

6. OPERATING PROCEDURES (Continued)

6.9 Balancing (Continued)

a. Daily Balancing (Continued)

Customers that receive gas through multiple meters may aggregate individually-metered quantities for purposes of making Daily Imbalance determinations. For customer meters without telemetry, the daily metered quantity shall be deemed to be the average daily quantity for that billing period.

b. Monthly Balancing

Customers are provided a monthly operating window under which the customer's cumulative imbalances must be within plus or minus five percent ($\pm 5\%$) of the month's total of daily net scheduled transportation quantities, including any Company-approved imbalance adjustment quantity, or 1,500 therms, whichever is greater.

c. Operational Flow Order (OFO)

The purpose of an OFO is to protect system integrity or manage upstream resources. The following conditions shall apply to the Company's issuance of OFOs:

Issued:
April 30, 2019

Effective:
April 15, 2019

Advice Letter No.:
511

Issued by
Justin Lee Brown
Senior Vice President

SCHEDULE NO. ST-1/NT-1

TRANSPORTATION OF CUSTOMER-SECURED NATURAL GAS
(Continued)

6. OPERATING PROCEDURES (Continued)

6.9 Balancing (Continued)

c. Operational Flow Order (OFO) (Continued)

1. The Company will issue and implement an OFO as soon as possible before 7:30 a.m. Pacific Clock Time on the day prior to the day of gas flow, however, the Company reserves the right to issue and/or modify an OFO at any time. Notice to customers of an OFO event, and/or changes during the OFO will be provided electronically or by other means mutually acceptable to the Company and the Customer. The notice will contain, at a minimum, (1) the starting time of the OFO, (2) the OFO Stage from Section 6.9.c.3., (3) the anticipated OFO duration, (4) the extent of the OFO (system wide, local, or customer specific), (5) the reason(s) for the OFO and (6) if not readily available through other Company sources, the prior day's Btu conversion factor. A specific OFO may not last longer than three days. If at the end of the three days the conditions requiring the OFO still exist, a new OFO will be issued.
2. If an OFO is issued or modified during the gas day, the Company will make a good faith effort to notify customers at least one hour prior to the Cycle 3, Cycle 4 and Cycle 5 Intraday Nomination deadline set forth in Section 6.1. When an OFO is issued, or modified during the gas day, the Daily Imbalance Window will be prorated based on the number of hours each imbalance tolerance band was effective during the day.

Issued:
April 30, 2019

Effective:
April 15, 2019

Advice Letter No.:
511

Issued by
Justin Lee Brown
Senior Vice President

SCHEDULE NO. ST-1/NT-1

TRANSPORTATION OF CUSTOMER-SECURED NATURAL GAS
(Continued)

6. OPERATING PROCEDURES *(Continued)*

6.9 Balancing *(Continued)*

c. Operational Flow Order (OFO) *(Continued)*

3. While an OFO is in effect, customers' Daily Imbalances must be within the Tolerance Bands specified below (or as prorated per Section 6.9.c.2. above) or be subject to applicable Noncompliance Charge(s).

	<u>Tolerance Band</u> <u>(the Greater of)</u>	<u>Noncompliance</u> <u>Charge per Therm</u> <u>in Excess of Tolerance</u>
No OFO:	+/- 10% or 10,000 Therms	\$0.00
Stage 1:	+/- 7% or 5,000 Therms	\$0.25
Stage 2:	+/- 3% or 300 Therms	\$0.50
Stage 3:	+/- 0% or 0 Therms	\$1.50

Subject to restrictions defined in Section 6.9.c.3.i below, if the aggregate Daily Imbalances of all transportation customers who are (1) included in an OFO event declared under this Section 6.9.c and (2) subject to the payment of imbalance penalties under this Section 6.9.c.3 exceeds the applicable tolerance band (such excess is the excess imbalance quantities), the Company's OFO Noncompliance Charge(s) will be assessed as follows. Individual transportation customer Excess Imbalance Quantities established during a Stage 1 and/or Stage 2 OFO will be subject to the Company's applicable Stage 1 and Stage 2 noncompliance charges. Individual transportation customer Excess Imbalance Quantities established during a Stage 3 OFO will be subject to the Company's Stage 3 noncompliance charge only when the Company is penalized or flow controlled by one or more of its upstream pipelines for imbalances established during the same day(s) the Company's Stage 3 OFOs were in effect.

<p>Issued:</p> <p style="text-align: center;">April 30, 2019</p> <p>Effective:</p> <p style="text-align: center;">April 15, 2019</p> <p>Advice Letter No.:</p> <p style="text-align: center;">511</p>	<p>Issued by</p> <p>Justin Lee Brown</p> <p>Senior Vice President</p>	
---	---	--

SCHEDULE NO. ST-1/NT-1

TRANSPORTATION OF CUSTOMER-SECURED NATURAL GAS
(Continued)

6. OPERATING PROCEDURES *(Continued)*

6.9 Balancing *(Continued)*

c. Operational Flow Order (OFO) *(Continued)*

3. *(Continued)*

Otherwise such Stage 3 excess imbalance quantities will be subject to the Company's Stage 2 noncompliance charge. Subject to restrictions defined in Section 6.9.c.3.i below, OFO noncompliance charges will not be assessed if the aggregate Daily Imbalances of all transportation customers who are (1) included in an OFO event declared under this Section 6.9.c and (2) subject to the payment of imbalance penalties under this Section 6.9.c.3 are within the applicable tolerance band.

i. When gas has been withdrawn from Great Basin Gas Transmission Company's Liquefied Natural Gas (LNG) Facility during an OFO event for use by customers on the Company's system, transportation customers located downstream from the LNG facility will not be allowed to aggregate quantities with transportation customers located upstream from the LNG facility. In such case(s), Daily Imbalances for transportation customers located downstream and upstream from the LNG facility will be separately aggregated for purposes of determining whether the Company's OFO noncompliance charge(s) are applicable.

The Company will not assess any daily charges during an OFO event based on estimated daily usage for telemetered customers.

<p>Issued: April 28, 2023</p> <p>Effective: July 11, 2023</p> <p>Advice Letter No.: AL 534</p>	<p>Issued by Amy L. Timperley Senior Vice President/ Chief Regulatory Officer</p>	
---	--	--

T
T

T
T
T

SCHEDULE NO. ST-1/NT-1

TRANSPORTATION OF CUSTOMER-SECURED NATURAL GAS
(Continued)

6. OPERATING PROCEDURES *(Continued)*

6.9 Balancing *(Continued)*

c. Operational Flow Order (OFO) *(Continued)*

4. The Company shall not impose a penalty more than once on the same quantities of unauthorized deliveries, and whenever the Company imposes a penalty for unauthorized deliveries pursuant to Section 6.9.c.3, the Company shall not as well pass along any penalties associated with the same quantities of unauthorized deliveries which may be assessed on the Company by upstream pipelines.
5. Any charges for noncompliance collected under this provision shall be credited to Account No. 191, Unrecovered Purchased Gas Costs.

The Company will issue and implement an OFO in one direction only. In such case, the Company's normal daily balancing provisions, i.e. the greater of plus or minus ten percent ($\pm 10\%$) of transportation quantities scheduled for burn on that gas day or 10,000 therms, will apply in the opposite direction. The Company may issue a "Hold Burn to Scheduled Quantities" notice asking customers to match their burn to scheduled quantities prior to initiating an OFO event. Generally, an OFO event will begin with a Stage 1 notice; however, an OFO event, and associated noncompliance charge, may begin at any stage deemed necessary by the Company. The Company may subsequently evaluate the stage of the OFO, if necessary, to ensure system integrity or manage upstream resources subject to the same notification requirements set forth in Section 6.9.c.1. herein. The OFO Stage issued by the Company will depend upon the severity of upstream and/or system operating

R/C
R/C

T/L

<p>Issued: April 30, 2019</p> <p>Effective: April 15, 2019</p> <p>Advice Letter No.: 511</p>	<p>Issued by Justin Lee Brown Senior Vice President</p>	
---	---	--

SCHEDULE NO. ST-1/NT-1

TRANSPORTATION OF CUSTOMER-SECURED NATURAL GAS
(Continued)

6. OPERATING PROCEDURES *(Continued)*

6.9 Balancing *(Continued)*

c. Operational Flow Order (OFO) *(Continued)*

conditions. The Company will issue a Stage 3 OFO if it is in an imminent penalty or flow control situation with one or more of its upstream pipeline suppliers, or the continuous operations of its system are imperiled. The Company may subject a specific customer or specific group of customers to an elevated OFO Stage if those customer(s) do not comply with prior requests to balance daily scheduled quantities with daily metered quantities. The Company will only subject a specific customer or specific group of customers to an elevated OFO Stage if the customer(s) that may be subject to an elevated OFO State do not balance daily scheduled quantities with daily metered quantities.

6.10 Adjustments. Periodically, volume adjustments may be made by the upstream pipeline transporter or the customer's supplier or Agent. In such instances, the daily quantities invoiced will be compared with the customer's daily scheduled transportation quantities.

Should adjustments to the customer's scheduled transportation quantities become necessary, such adjustments will be reflected in the month in which the quantities were scheduled for purposes of administering this schedule.

6.11 Customer's Default. The Company shall not be required to perform or continue service on behalf of any customer that fails to comply with the terms contained in this schedule and the terms of the customer's service agreement with the Company. The Company shall have the right to waive any one or more specific defaults by any customer under any provision of this schedule or the service agreement provided, however, that no such waiver shall operate or be construed as a waiver of any other existing or future default or defaults, whether of a like or different character.

<p>Issued: April 30, 2019</p> <p>Effective: April 15, 2019</p> <p>Advice Letter No.: 511</p>	<p>Issued by Justin Lee Brown Senior Vice President</p>	
---	---	--

T
T
T
T
N
T
T
N
N
N
N

SCHEDULE NO. ST-1/NT-1

TRANSPORTATION OF CUSTOMER-SECURED NATURAL GAS
(Continued)

6. OPERATING PROCEDURES *(Continued)*

6.12 Customer's Creditworthiness. The Company shall not be required to perform or to continue service under this schedule on behalf of any customer who is or has become insolvent or who, at the Company's request, fails within a reasonable period to demonstrate creditworthiness; however, such customer may receive service under this schedule if the customer prepays for such service or furnishes good and sufficient security, as determined by the Company in its reasonable discretion, an amount equal to the cost of performing the service requested by the customer for a six month period. For purposes of this schedule, the insolvency of a customer shall be evidenced by the filing by such customer or any parent entity thereof (hereinafter collectively referred to as the customer) of a voluntary petition in bankruptcy or the entry of a decree or order by a court having jurisdiction in the premises adjudging the customer as bankrupt or insolvent, or approving as properly filed a petition seeking reorganization, arrangement, adjustment or composition of or in respect of the customer under the Federal Bankruptcy Act or any other applicable federal or state law, or appointing a receiver, liquidator, assignee, trustee, sequestrator (or other similar official) of the customer or of any substantial part of its property, or the ordering of the winding-up or liquidation of its affairs, with said order or decree continuing unstayed and in effect for a period of 60 consecutive days.

6.13 Other Procedures. The Company reserves the right to impose, at any time, any reasonable operating conditions upon the transportation of the customer's gas which the Company, in its sole good faith judgment, deems necessary to maintain the safe and efficient operation of its distribution system or to make the operating terms and conditions of service hereunder compatible with those of the upstream pipeline(s).

<p>Issued: December 31, 2018</p> <p>Effective: January 1, 2019</p> <p>Advice Letter No.:</p>	<p>Issued by Justin Lee Brown Senior Vice President</p>	
--	---	--

SCHEDULE NO. ST-1/NT-1

TRANSPORTATION OF CUSTOMER-SECURED NATURAL GAS
(Continued)

7. TRANSPORTATION IMBALANCE SERVICE

The Company will provide an Imbalance Service for individual customers when their daily or monthly metered quantities differ from their respective net scheduled daily or monthly transportation quantities to the Company's system. The Imbalance Service provided hereunder has two components: (1) an Imbalance Trading Service for monthly imbalances; and (2) Payment for Excess Imbalances for both daily and monthly excess imbalances.

7.1 Monthly Imbalance Trading Service

The Imbalance Trading Service will be facilitated through the Company's approved electronic method. Customers taking service under this schedule may trade their imbalances with other customers served under Schedule No. ST-1/NT-1. The customer's cumulative monthly imbalances will be stated on an imbalance report provided separately from the monthly bill. The imbalance report will serve as notice of current imbalances. Imbalance trading is allowed for monthly imbalances only. No trades of Daily Imbalances will be allowed. Only those imbalances occurring in the same period are eligible for trading.

- a. Beginning at 7:00 A.M. Pacific Clock Time on the tenth calendar day of the month following notification, customers may enter Company's approved electronic method to post available monthly imbalances. The trading period will end at 2:00 P.M. Pacific Clock Time on the 25th calendar day of the month. If the 25th falls on a weekend or holiday, the trade period will close the following business day.
- b. Trading of imbalance quantities may only reduce a customer's monthly imbalance toward, but not beyond a zero-imbalance level.

<p>Issued: April 30, 2019</p> <p>Effective: April 15, 2019</p> <p>Advice Letter No.: 511</p>	<p>Issued by Justin Lee Brown Senior Vice President</p>	
---	---	--

T
T
T
T

SCHEDULE NO. ST-1/NT-1

TRANSPORTATION OF CUSTOMER-SECURED NATURAL GAS
(Continued)

7. TRANSPORTATION IMBALANCE SERVICE (Continued)

7.1 Monthly Imbalance Trading Service (Continued)

- c. Once customers have agreed on the terms of a trade, both parties must complete and send to the Company by a Company-approved method, a copy of the Imbalance Trading Request Form (Form No. 879.0). The Company will then validate the trade and adjust the participants' accounts. The Imbalance Trading Request Form must be received by the Company by the close of the trading period as set forth in Section 7.1.a. No confirmation of an imbalance trade will be made until signed forms are received via a Company-approved method. The Company will notify participants through the Company's approved electronic method or other notice once the trade is validated.
- d. After the imbalance trading period, excess imbalance charges (see Sections 7.2 and 7.3) will be applied to all imbalance quantities in excess of the applicable monthly operating window.
- e. Cumulative imbalances for customers with multiple meters under a single transportation service agreement will be determined by subtracting the customer's aggregated metered quantities, including the effect of any adjustment for cycle billing, from the total quantities scheduled under the customer's service agreement. Imbalances will be allocated between the customer's meters based on metered quantities, including the effect of any adjustment for cycle billing. Customers with multiple meters will not be allowed to trade imbalances based on individual meters or sales accounts.

Issued:
April 30, 2019

Effective:
April 15, 2019

Advice Letter No.:
511

Issued by
Justin Lee Brown
Senior Vice President

SCHEDULE NO. ST-1/NT-1

TRANSPORTATION OF CUSTOMER-SECURED NATURAL GAS
(Continued)

7. TRANSPORTATION IMBALANCE SERVICE (Continued)

7.1 Monthly Imbalance Trading Service (Continued)

- f. The customer is solely responsible for contacting other transportation customers to explore opportunities for trading imbalances.
- (1) Southwest Gas assesses its transportation volume quantity based on the transportation billing quantities, adjusted for any quantities traded pursuant to this section.
- (2) It is the customer's sole responsibility to consider all gas supply, interstate and intrastate cost impacts when transacting imbalance trades.
- g. If, as the result of a billing error, metering error or adjustments of scheduled supply, a customer trades an incorrect imbalance quantity based on notification by the Company, the Company will not be liable for any financial losses or damages incurred by the customer nor will the Company be financially liable to any of the customer's imbalance trading partners. If, because of such error, the Company overbills the customer, the Company shall refund the difference without interest. If the Company underbills the customer, the customer shall be liable for the undercharge, including any associated excess imbalance charges. For purposes of determining imbalances and any applicable charges hereunder, the Company will include billing adjustments to the quantity in prior periods as part of the current month's activity. Trades occurring in prior periods will not be affected by such billing adjustments.

<p>Issued: April 30, 2019</p> <p>Effective: April 15, 2019</p> <p>Advice Letter No.: 511</p>	<p>Issued by Justin Lee Brown Senior Vice President</p>	
--	---	--

SCHEDULE NO. ST-1/NT-1

TRANSPORTATION OF CUSTOMER-SECURED NATURAL GAS
(Continued)

7. TRANSPORTATION IMBALANCE SERVICE *(Continued)*

7.2 Payment for Excess Imbalances

Customers will be assessed imbalance charges if an imbalance exists in excess of applicable daily or monthly operating windows set forth in Section 6.9 hereof. Monthly imbalances will be adjusted to reflect imbalance trading activity before assessing any imbalance charges. The portion of any imbalance quantity established by a customer in excess of the applicable daily or monthly operating window is defined as an excess imbalance quantity. Noncompliance Charges pursuant to Section 6.9.c.3 of this schedule, and the customer's otherwise applicable gas sales tariff schedule, any daily or monthly excess imbalance quantity shall be billed as follows:

a. Positive Excess Imbalance

Positive excess imbalances shall be retained by the Company and the excess imbalance eliminated after the customer's bill is credited with the lower of the following two gas costs for each term of the excess imbalance in addition to the customer's applicable transportation quantity charge:

- (1) 50% of the Imbalance Commodity Charge, which is defined as the total recorded test period commodity cost purchased by the Company for sales customers subject to the Annual Rate Adjustment plus applicable upstream pipeline volumetric charges, divided by the total quantity of gas purchased by such customers over the same period. The rate is shown in Footnote 2 of the Statement of Rates of this Nevada Gas Tariff; or
- (2) The lowest incremental cost of gas, including the lowest incremental upstream interstate transportation charges, purchased by the Company during the same month.

<p>Issued: April 30, 2019</p> <p>Effective: April 15, 2019</p> <p>Advice Letter No.: 511</p>	<p>Issued by Justin Lee Brown Senior Vice President</p>	
---	---	--

SCHEDULE NO. ST-1/NT-1

TRANSPORTATION OF CUSTOMER-SECURED NATURAL GAS
(Continued)

7. TRANSPORTATION IMBALANCE SERVICE (Continued)

7.2 Payment for Excess Imbalances (Continued)

b. Negative Excess Imbalance

Negative excess imbalances shall be eliminated after the customer is billed the higher of the following two gas costs for each therm of the excess imbalance in addition to the customer's applicable transportation quantity charge:

- (1) 150% of the sum of the Imbalance Commodity Charge and the Imbalance Reservation Charge. The Imbalance Commodity Charge is defined in Section 7.2 a. (1) herein. The Imbalance Reservation Charge is defined as the total recorded pipeline capacity and storage charges during the Annual Rate Adjustment test period, divided by the total quantity of gas purchased by such customers over the same period. Both rates are shown in Footnote 2 of the Statement of Rates of this Nevada Gas Tariff; or
- (2) The highest incremental cost of gas, including the highest incremental upstream interstate transportation charges, purchased by the Company during the same month.

<p>Issued: April 30, 2019</p> <p>Effective: April 15, 2019</p> <p>Advice Letter No.: 511</p>	<p>Issued by Justin Lee Brown Senior Vice President</p>	
--	---	--

SCHEDULE NO. ST-1/NT-1

TRANSPORTATION OF CUSTOMER-SECURED NATURAL GAS
(Continued)

7. TRANSPORTATION IMBALANCE SERVICE *(Continued)*

- 7.3 Subject to mitigation through imbalance trading, if a customer is assessed a monthly imbalance charge based on the Company's billing information that is later determined to be in error, the portion of the imbalance charge not assessable based on the corrected billing information shall be reversed on the customer's bill without interest. If a customer is not assessed a monthly imbalance charge based on the Company's billing information that is later determined to be in error, the customer shall be billed for any applicable imbalance charges determined to be assessable based on the revised billing information.
- 7.4 Should a customer elect to discontinue taking service under this schedule and change to a sales service schedule, the Company may allow, in its sole good faith judgment, any remaining imbalance within the applicable operating window to be cleared as follows:
- a. The Company shall credit the customer for any positive imbalance quantity at a price equal to the lowest incremental cost of gas purchased by the Company during the prior month for gas delivered to the applicable rate jurisdiction.
 - b. For any remaining negative imbalance quantity, the customer shall pay the Company for the imbalance quantity at the otherwise applicable gas sales tariff rate adjusted to exclude the Deferred Energy Account Adjustment.
 - c. The customer may trade any remaining imbalance pursuant to this section; however, if a customer does not enter a trade for any remaining imbalance quantity, the Company will clear the remaining imbalance by utilizing (a) or (b) herein, as applicable.

<p>Issued: April 30, 2019</p> <p>Effective: April 15, 2019</p> <p>Advice Letter No.: 511</p>	<p>Issued by Justin Lee Brown Senior Vice President</p>	
---	---	--

SCHEDULE NO. ST-1/NT-1

TRANSPORTATION OF CUSTOMER-SECURED NATURAL GAS
(Continued)

7. TRANSPORTATION IMBALANCE SERVICE (Continued)

7.5 Under no circumstances shall Sections 7.2 and 7.4 herein be considered as giving the customer any right to take excess imbalance quantities, nor shall Sections 7.2 and 7.4 or payment thereunder be considered as a substitute for any other remedy available to the Company against the offending customer for failure to respect its obligation to stay within the authorized quantities.

7.6 All gas cost imbalance charges received or paid by the Company will be credited or debited to Account No. 191, Unrecovered Purchased Gas Costs, as appropriate.

8. FACILITY ADDITIONS

Any facilities which must be installed by the Company to serve the customer will be constructed in accordance with the Rules included in this Nevada Gas Tariff. All customers who wish to receive transportation service under this schedule must install telemetry equipment at each meter location with a daily requirement of 500 therms or more. Such telemetry equipment shall be installed at the customer's expense. If the installation of telemetry equipment is not required by the Company but requested by the customer, the Company may install and bill the customer for the cost of such equipment.

<p>Issued: April 30, 2019</p> <p>Effective: April 15, 2019</p> <p>Advice Letter No.: 511</p>	<p>Issued by Justin Lee Brown Senior Vice President</p>	
--	---	--

C
C
N

SCHEDULE NO. ST-1/NT-1

TRANSPORTATION OF CUSTOMER-SECURED NATURAL GAS
(Continued)

9. THIRD PARTY CHARGES

The customer shall reimburse the Company for any charges rendered or billed to the Company by any other upstream pipeline transporters, suppliers or gas gatherers, either before or after termination of the service agreement, which the Company, in its sole good faith opinion, determines have been incurred because of the transportation of customer's gas hereunder and should, therefore, appropriately be borne by the customer. Such charges, whether levied in dollars or gas, may include, but shall not be limited to, standby charges or reservation fees, prepayments, applicable taxes, applicable fuel reimbursement, shrinkage, lost and unaccounted for quantities, G.R.I. surcharges, penalty charges, ACA Charges, or filing fees. The customer will reimburse the Company for all such charges incurred by the Company as rendered, irrespective of the actual quantities of natural gas delivered to the customer.

10. POSSESSION OF GAS AND RESPONSIBILITY

As between the Company and the customer, the customer shall be deemed to be in control and possession of the gas until it has been delivered to the Company for transportation at the Receipt Point(s). The Company shall thereupon be deemed to be in control and possession of the gas until the gas shall have been delivered to the customer at the Delivery Point(s), after which the customer shall be deemed to be in control and possession. The customer shall have no responsibility with respect to any gas after it has been delivered to the Company at the Receipt Point(s) because of anything which may be done, happen or arise with respect to said gas, until said gas is delivered to the customer at the Delivery Point(s).

The Company shall have no responsibility with respect to said gas prior to its delivery to the Company at the Receipt Point(s) or after its delivery to the customer at the Delivery Point(s) because of anything which may be done, happen or arise with respect to said gas prior to such receipt or after such delivery.

<p>Issued: April 30, 2019</p> <p>Effective: April 15, 2019</p> <p>Advice Letter No.: 511</p>	<p>Issued by Justin Lee Brown Senior Vice President</p>	
---	---	--

SCHEDULE NO. ST-1/NT-1

TRANSPORTATION OF CUSTOMER-SECURED NATURAL GAS
(Continued)

11. WARRANTY OF TITLE

The Company accepts the customer's gas at Receipt Point(s) subject to the understanding that the customer warrants that it will, at the time of delivery of gas to the Company for transportation, have good title to all gas so delivered to the Company free and clear of all liens, encumbrances and claims whatsoever; that it will at such time of delivery have the right to deliver such gas to the Company; and that it will indemnify the Company and hold the Company harmless from all adverse claims of all persons to such gas.

The Company warrants that, at the time of delivery of the transported gas to the customer at the Delivery Point(s), it will not have encumbered the gas in any manner whatsoever from the time the gas is accepted at the Receipt Point(s) until the gas is delivered to the customer at the Delivery Point(s).

12. MEASUREMENT BASE

Refer to Rule No. 2 of this Nevada Gas Tariff.

13. HEAT CONTENT

Refer to Rule No. 2 of this Nevada Gas Tariff.

14. BILLING AND PAYMENT

14.1 Billing. The Company shall render a bill to the customer on or before the tenth day of each month for all service rendered to the customer during the preceding calendar month.

<p>Issued: April 30, 2019</p> <p>Effective: April 15, 2019</p> <p>Advice Letter No.: 511</p>	<p>Issued by Justin Lee Brown Senior Vice President</p>	
--	---	--

SCHEDULE NO. ST-1/NT-1

TRANSPORTATION OF CUSTOMER-SECURED NATURAL GAS
(Continued)

14. BILLING AND PAYMENT (Continued)

14.2 Payment. On or before the 25th day of each month, the customer shall pay the Company for the service rendered hereunder during the preceding month as billed by the Company. Such payment shall be made in immediately-available funds on or before the due date to a depository designated by the Company. If the 25th falls on a day that the designated depository is not open in the normal course of business to receive the customer's payment, then payment shall be made on or before the last business day preceding the 25th that such depository is available.

14.3 Late Charge. Should the customer fail to pay all the amount of any bill for gas delivered under the executed service agreement as herein provided, when such amount is due, a late charge of five percent on the first \$200 of the monthly bill, plus two percent of any balance above \$200, shall be assessed.

14.4 Delayed Bill. If presentation of a bill to the customer by the Company is delayed after the tenth day of the month, then the time of payment shall be extended accordingly, unless the customer is responsible for such delay.

14.5 Adjustment of Errors. In the event an error is discovered in any invoice that the Company renders, such error shall be adjusted within 30 days of the determination thereof provided, however, that any claim for adjustment must be made within 12 months from the date of such invoice.

15. GENERAL TERMS AND CONDITIONS

Except as qualified in this schedule, all the General Terms and Conditions are applicable to this schedule and are hereby made a part hereof.

<p>Issued: April 30, 2019</p> <p>Effective: April 15, 2019</p> <p>Advice Letter No.: 511</p>	<p>Issued by Justin Lee Brown Senior Vice President</p>	
--	---	--

SCHEDULE NO. M2Z

MOVE2ZERO CARBON OFFSET PROGRAM

APPLICABILITY

The Move2Zero Carbon Offset Program ("M2Z Program") is available, in conjunction with the Utility's defined sales rate schedules, to Customers who choose to participate in the M2Z Program.

TERRITORY:

Throughout the Company's certificated Nevada Service Areas.

RATES

A Customer electing to participate in the M2Z Program shall be responsible for all charges and rates specified in the Customer's otherwise applicable rate schedule. In addition, the Customer shall be responsible for the monthly premium charge associated with the Customer's selected amount of carbon offsets, or "blocks," that the Company will purchase on behalf of that Customer. One block will cost \$5.00 per month and will offset 10 therms of combustion-related natural gas usage per month. The number of blocks that a Customer may purchase is to be determined by the Customer.

The minimum charge per month shall be the sum of the minimum charge specified in the Customer's otherwise applicable rate schedule, plus the product of the \$5.00 per block charge multiplied by the number of blocks the Customer elects to purchase.

TERM

For customers who participate in the M2Z Program and who receive service under the Company's SG-RS/NG-RS, SG-RM/NG-RM or SG-G1/NG-G1 rate schedules, the Customer or the Company may terminate the Customer's participation in the M2Z Program by giving at least thirty (30) days prior written notice of such termination. Customers who participate in the M2Z Program and who receive service under one of the Company's other sales rate schedules may, at the Company's discretion, require different block pricing or specific term length, or both.

<p>Issued: September 23, 2022</p> <p>Effective: October 1, 2022</p> <p>Advice Letter No.:</p>	<p>Issued by Amy L. Timperley Senior Vice President/ Chief Regulatory Officer</p>	
---	---	--

N
N

SCHEDULE NO. M2Z

MOVE2ZERO CARBON OFFSET PROGRAM
(Continued)

LATE CHARGE

No late payment charge will be assessed to amounts not paid by the Customer under this Program. However, Late Charges for the Customer's otherwise applicable rate schedule are applicable. Failure of a Customer to pay any amounts due pursuant to the M2Z Program shall not result in disconnection of service to the Customer.

COST RECOVERY

The Company will not seek to recover any costs beyond what it receives through Program participant charges. Participant charges will be used to fund the cost of carbon offsets, ongoing administration, marketing and overhead. The Program is a self-funded, pass-through service. The Company intends to recognize Program revenues and expenditures in a regulatory asset account, which includes carrying charges consistent with the Company's currently authorized rate of return. Expenditures are required in order to establish participation in this service which means that they will be incurred prior to generation of revenues from Customers electing to participate in the Program.

<p>Issued: September 23, 2022</p> <p>Effective: October 1, 2022</p> <p>Advice Letter No.:</p>	<p>Issued by Amy L. Timperley Senior Vice President/ Chief Regulatory Officer</p>	
---	---	--

INTERSTATE PIPELINE CAPACITY SERVICES PROVISION

CAPACITY RELEASE SERVICE

Capacity Release Service will be provided by the Company pursuant to the terms and conditions set forth in the Company's upstream interstate pipeline service providers FERC approved tariffs. All capacity release credits received by the Company shall be credited to Account No. 191, Unrecovered Purchased Gas Costs.

Issued:

July 29, 2011

Effective:

July 21, 2011

Advice Letter No.:

469

Issued by
John P. Hester
Senior Vice President

SOUTHWEST GAS CORPORATION
P.O. Box 98510
Las Vegas, Nevada 89193-8510
Nevada Gas Tariff No. 7

Canceling 2nd Revised P.U.C.N. Sheet No. 86
1st Revised P.U.C.N. Sheet No. 86

HELD FOR FUTURE USE

Issued:
December 31, 2018

Effective:
January 1, 2019

Advice Letter No.:

Issued by
Justin Lee Brown
Senior Vice President

T

T

TAXES AND ASSESSMENTS NOT INCLUDED IN RATES

GENERAL

Rate schedules of the Company do not include any regulatory assessment, business license, franchise taxes or taxes based upon revenues or quantities of gas delivered in the counties, cities, municipalities or other tax jurisdictions throughout the certificated area of the Company's Nevada Service Areas.

APPLICABILITY

In order to collect the taxes and assessments for the various authorities, bills for gas service will be increased in an amount sufficient to cover the amount of such taxes and assessments.

Sales to certain governmental agencies, inter-utility sales, sales to industrial plants and certain revenues may be partially or fully exempt or excluded, pursuant to jurisdictional authority, from such charges, and accordingly no amount or a lesser amount will be added to the bills of customers within such classifications. Any customer that has established an exempt classification may be required to execute and deliver to the Company an appropriate instrument whereby such customer agrees to indemnify the Company in the event that it should later be determined by competent authority that such customer was not, in fact, an exempt classification.

<p>Issued: October 2, 2020</p> <p>Effective: October 7, 2020</p> <p>Advice Letter No.:</p>	<p>Issued by Justin Lee Brown Senior Vice President</p>	
--	---	--

GENERAL REVENUES ADJUSTMENT PROVISION

APPLICABILITY

The General Revenues Adjustment (GRA) Provision applies to the single-family and multi-family residential gas service schedules, G1, G2, G3, and G4 general gas service schedules in this Nevada Gas Tariff. The GRA specifies the procedures to allow the utility to recover its authorized Base Tariff General Rate (BTGR) revenues without regard to the difference in the quantity of natural gas delivered. BTGR revenues are those revenues collected through the fixed and variable margin component of the delivery charge of the Company's rates as stated on the Statement of Rates in this Nevada Gas Tariff.

TRACKING PERIOD

The tracking period shall be the first full twelve (12) month period following the implementation of the GRA Provision, and each twelve (12) month period thereafter.

GENERAL REVENUES ADJUSTMENT DEFERRALS

An annual GRA deferral for each applicable gas service schedule will be calculated as follows:

1. For each month of the tracking period, the difference between the authorized per customer general revenue, as stated herein, and the per customer general revenue billed for the month, shall be multiplied by the billed customers for the month.
2. The annual general revenue deferral is equal to the sum of the tracking period monthly computations as described above.

The annual GRA deferrals calculated above for each customer class shall be recorded in a separate sub-account of Account No. 182.3 (GRA sub-account) and included in the determination of the balance used to calculate the GRA rates.

GENERAL REVENUES ADJUSTMENT RATE

The GRA rates are per therm charges or credits applicable to each service schedule subject to this provision to recover or refund any GRA deferrals. The Company shall file annually to update the GRA rates. The GRA rates will be calculated by dividing the balances in the GRA sub-accounts at the end of the tracking period by the applicable tracking period sales volume.

<p>Issued: <p align="center">April 1, 2022</p> <p>Effective: <p align="center">April 1, 2022</p> <p>Advice Letter No.:</p> </p></p>	<p align="center">Issued by Amy L. Timperley Vice President</p>	
---	---	--

C

T
T

GENERAL REVENUES ADJUSTMENT PROVISION

(Continued)

AUTHORIZED GENERAL REVENUES PER CUSTOMER

Average Margin per Customer per Month – Southern Nevada

Month	Residential Gas Service		General Gas Service			
	SG-RS Single	SG-RM Multi	SG-G1	SG-G2	SG-G3	SG-G4
January	\$ 61.64	\$ 31.80	\$ 122.59	\$ 430.04	\$ 1,729.31	\$10,698.07
February	\$ 51.71	\$ 27.84	\$ 101.04	\$ 388.51	\$ 1,519.58	\$10,043.38
March	\$ 41.53	\$ 24.52	\$ 85.40	\$ 364.88	\$ 1,477.93	\$10,632.52
April	\$ 31.71	\$ 20.82	\$ 69.89	\$ 333.57	\$ 1,327.98	\$10,026.77
May	\$ 28.98	\$ 20.23	\$ 67.43	\$ 323.31	\$ 1,254.33	\$ 9,934.10
June	\$ 26.96	\$ 19.19	\$ 52.91	\$ 258.49	\$ 964.88	\$ 9,061.60
July	\$ 25.02	\$ 18.57	\$ 53.37	\$ 265.94	\$ 1,018.94	\$ 9,259.32
August	\$ 23.99	\$ 18.04	\$ 51.62	\$ 256.16	\$ 973.39	\$ 9,222.04
September	\$ 24.49	\$ 18.21	\$ 53.16	\$ 264.28	\$ 1,022.03	\$ 9,253.61
October	\$ 25.60	\$ 18.43	\$ 56.01	\$ 277.06	\$ 1,077.85	\$ 9,609.67
November	\$ 30.46	\$ 20.62	\$ 63.38	\$ 305.02	\$ 1,228.41	\$10,055.23
December	\$ 48.53	\$ 27.36	\$ 92.28	\$ 376.49	\$ 1,532.74	\$10,605.29
Total	\$ 420.62	\$ 265.63	\$ 869.08	\$3,843.75	\$15,127.37	\$118,401.60

Average Margin per Customer per Month – Northern Nevada

Month	Residential Gas Service		General Gas Service			
	NG-RS Single	NG-RM Multi	NG-G1	NG-G2	NG-G3	NG-G4
January	\$ 67.47	\$ 40.90	\$ 101.02	\$ 402.63	\$ 1,346.41	\$ 6,367.97
February	\$ 57.38	\$ 35.62	\$ 89.46	\$ 362.71	\$ 1,225.02	\$ 6,242.73
March	\$ 51.93	\$ 33.81	\$ 81.40	\$ 341.86	\$ 1,201.93	\$ 7,177.61
April	\$ 41.58	\$ 28.57	\$ 66.82	\$ 304.02	\$ 1,104.43	\$ 6,685.89
May	\$ 31.78	\$ 23.03	\$ 55.78	\$ 264.37	\$ 1,119.08	\$ 6,439.85
June	\$ 27.13	\$ 20.27	\$ 49.72	\$ 235.58	\$ 1,125.19	\$ 5,186.92
July	\$ 23.25	\$ 17.78	\$ 47.13	\$ 223.03	\$ 1,079.95	\$ 5,960.59
August	\$ 22.57	\$ 17.42	\$ 46.78	\$ 218.91	\$ 1,023.82	\$ 6,109.76
September	\$ 23.11	\$ 17.56	\$ 47.09	\$ 221.90	\$ 1,098.53	\$ 6,344.15
October	\$ 26.97	\$ 19.32	\$ 50.86	\$ 239.69	\$ 1,155.19	\$ 6,497.13
November	\$ 39.18	\$ 25.00	\$ 66.05	\$ 287.20	\$ 1,204.07	\$ 5,904.29
December	\$ 57.37	\$ 35.14	\$ 89.76	\$ 362.74	\$ 1,267.51	\$ 6,440.83
Total	\$ 469.72	\$ 314.42	\$ 791.87	\$3,464.64	\$13,951.13	\$75,357.72

<p>Issued: April 10, 2024</p> <p>Effective: April 15, 2024</p> <p>Advice Letter No.:</p>	<p>Issued by Amy L. Timperley Senior Vice President/ Chief Regulatory Strategy and Planning Officer</p>	
--	---	--

UNRECOVERED GAS COST EXPENSE PROVISION

APPLICABILITY

The Unrecovered Gas Cost Expense (UGCE) Provision applies to all gas sales service schedules in this Nevada Gas Tariff. The UGCE specifies the procedures to be followed for recovering bad debt expense associated with gas costs.

TEST PERIOD

The test period shall be the 12 month recorded period used to establish the Deferred Energy Account Adjustment Rates in the Company's Annual Rate Adjustment filing, unless otherwise provided for by the Commission.

UGCE RATES

The UGCE rates are per therm charges or credits to recover bad debt expense associated with gas costs and recover or refund any UGCE deferrals. Separate UGCE rates will be maintained for the Company's Northern and Southern Nevada service areas. The Company shall update the UGCE rates in its Annual Rate Adjustment filing, unless otherwise provided for by the Commission. The UGCE adjustment rates will be determined in the following manner:

1. The UGCE Base Rate will be determined by dividing the 12 month test period net gas cost write-offs by the applicable test period sales volume.
2. The UGCE Adjustment Rate will be calculated by dividing the test period unrecovered gas cost expense deferral account ending balance by the applicable test period sales quantities.

<p>Issued: December 31, 2018</p> <p>Effective: January 1, 2019</p> <p>Advice Letter No.:</p>	<p>Issued by Justin Lee Brown Senior Vice President</p>	
--	---	--

UNRECOVERED GAS COST EXPENSE PROVISION
(Continued)

UGCE DEFERRALS

Entries shall be recorded to the Company's Northern and Southern Nevada UGCE balancing accounts each month as follows:

1. A debit (positive) will be recorded in a separate sub-account of FERC Account No. 182.3, with an offset to uncollectible accounts expense (904.0) equal to the actual month net write-off.
2. A credit (negative) will be recorded to Account No. 182.3, with an offset to other gas revenue (495.0), equal to the amount collected from customers during the month through the UGCE Base Rate and the UGCE Adjustment Rate.
3. A debit (positive) or credit (negative) will be recorded in the account equal to the previous months ending balance multiplied by a carrying charge rate of one-twelfth (1/12) of the overall rate of return most recently authorized by the Commission. The carrying charge rate must be applied to the entire balance in the account. Contra entries for carrying charges shall be made to FERC Account No. 419 (if the balance in the account is a debit balance) or FERC Account No. 431 (if the balance in the account is a credit balance).

<p>Issued: December 31, 2018</p> <p>Effective: January 1, 2019</p> <p>Advice Letter No.:</p>	<p>Issued by Justin Lee Brown Senior Vice President</p>	
--	---	--

CONTRACT TRANSITION ADJUSTMENT PROVISION

APPLICABILITY

The Contract Transition Adjustment Provision (CTAP) applies to all rate schedules in this Nevada Gas Tariff. The Company will maintain separate CTAP accounting for its Northern Nevada Division and Southern Nevada Division.

The CTAP specifies the procedures to allow the utility to recover or return the difference in the Company's actual Base Tariff General Rate (BTGR) revenues derived from customers with discounted rate contracts or contracts for special services (collectively, Contracts) who transition to Schedule No. SG-G5, SG-G6 or NG-G5, and the amount for each customer that was included in the calculation of the Company's authorized BTGR revenues, adjusted for any increase in contract rates and revenues resulting from annual escalations of those rates and revenues due to annual changes in the gross domestic product deflator or consumer price index as applicable in the customer's Contracts.

BTGR revenues are those revenues collected through the margin portion of the fixed and variable delivery charge components of the Company's rates as stated on the Statement of Rates in this Nevada Gas Tariff and inflation adjusted revenues collected from customers served under Contracts.

TRACKING PERIOD

The initial tracking period shall be the first period including at least twelve (12) months ending September 30 following the transition of the customer from a Contract to Schedule No. SG-G5, SG-G6 or NG-G5, and each twelve (12) month period ending September 30 thereafter.

The Company will cease tracking the CTAP for a transitioning customer when that customer is included in a cost-of-service study as a Schedule No. SG-G5, SG-G6 or NG-G5 customer when rates are effective in the first general rate case filed after the customer transitions from a Contract to Schedule No. SG-G5, SG-G6 or NG-G5.

<p>Issued: April 10, 2024</p> <p>Effective: April 15, 2024</p> <p>Advice Letter No.:</p>	<p>Issued by Amy L. Timperley Senior Vice President/ Chief Regulatory Strategy and Planning Officer</p>	
--	---	--

CONTRACT TRANSITION ADJUSTMENT PROVISION

CTAP REVENUES ADJUSTMENT DEFERRALS

An annual CTAP revenues adjustment deferral will be calculated as follows:

1. For each month of the tracking period, the difference between each transitioning customer's monthly BTGR revenues included in the calculation of the Company's authorized BTGR rates, adjusted for any increase in contract rates and revenues resulting from annual escalations of those rates and revenues due to annual changes in the gross domestic product deflator or consumer price index as applicable in the customer's Contract and the actual monthly BTGR revenues received from each customer served under Schedule Nos. SG-G5, SG-G6, and NG-G5.
2. The annual CTAP revenue deferral is equal to the sum of the tracking period monthly computations as described above. The annual CTAP deferrals calculated above shall be recorded in a separate sub-account of Account No. 182.3 (CTAP sub-account) and included in the determination of the balance used to calculate the CTAP rate. The Company shall separately track deferrals for each transitioning customer in the CTAP sub-account.

CONTRACT TRANSITION ADJUSTMENT PROVISION RATE

The CTAP rate is a per therm charge or credit applicable to each rate schedule to recover or refund any CTAP deferrals. The Company shall update the CTAP rate in its Annual Rate Adjustment Application. The CTAP rates will be calculated by dividing the balance in the CTAP sub-account at the end of the tracking period by the total therms delivered to all full margin customer classes during the tracking period.

<p>Issued: April 10, 2024</p> <p>Effective: April 15, 2024</p> <p>Advice Letter No.:</p>	<p>Issued by Amy L. Timperley Senior Vice President/ Chief Regulatory Strategy and Planning Officer</p>	
--	---	--

LARGE CUSTOMER ADJUSTMENT PROVISION

APPLICABILITY

The Large Customer Adjustment Provision (LCAP) applies to all Southern Nevada rate schedules in this Nevada Gas Tariff. The (LCAP) specifies the procedures to allow the utility to recover or return the difference in the Company's actual Base Tariff General Rate (BTGR) revenues derived from customers served under Schedule Nos. SG-G5 and SG-G6, and the amount for each customer that was included in the calculation of the Company's authorized BTGR revenues. BTGR revenues are those revenues collected through the margin portion of the fixed and variable delivery charge components of the Company's rates as stated on the Statement of Rates in this Nevada Gas Tariff.

CUSTOMER CLASS DETERMINATION & TRACKING PERIOD

On September 30 of each year during the rate effective period of a general rate case application, the Company will determine if any customer that was classified as a SG-G5 or SG-G6 customer during the test year of the general rate case application should be reclassified to the other rate schedule.

If a customer qualifies for reclassification, the Company will track the difference in revenues for that customer that were included in the general rate case application and the actual revenues for the 12 months beginning on October 1.

LCAP REVENUES ADJUSTMENT DEFERRALS

An annual LCAP revenues adjustment deferral will be calculated as follows:

1. For each month of the tracking period, the difference between each reclassified customer's monthly BTGR revenues included in the calculation of the Company's authorized BTGR rates and the actual monthly BTGR revenues received from each reclassified customer served under Schedule Nos. SG-G5 and SG-G6.
2. The annual LCAP revenue deferral is equal to the sum of the tracking period monthly computations as described above. The annual LCAP deferrals calculated above shall be recorded in a separate sub-account of Account No. 182.3 LCAP sub-account) and included in the determination of the balance used to calculate the LCAP rates. The Company shall separately track deferrals for each reclassified customer in the LCAP sub-account.

<p>Issued: April 10, 2024</p> <p>Effective: April 15, 2024</p> <p>Advice Letter No.:</p>	<p>Issued by Amy L. Timperley Senior Vice President/ Chief Regulatory Strategy and Planning Officer</p>	
--	---	--

LARGE CUSTOMER ADJUSTMENT PROVISION

LARGE CUSTOMER ADJUSTMENT PROVISION RATE

The LCAP rate is a per therm charge or credit applicable to each rate schedule to recover or refund any LCAP deferrals. The Company shall update the LCAP rate in its Annual Rate Adjustment Application. The LCAP rates will be calculated by dividing the balance in the LCAP sub-account at the end of the tracking period by the total therms delivered to all full margin customer classes during the tracking period.

<p>Issued: April 10, 2024</p> <p>Effective: April 15, 2024</p> <p>Advice Letter No.:</p>	<p>Issued by Amy L. Timperley Senior Vice President/ Chief Regulatory Strategy and Planning Officer</p>	
--	---	--

N
N

SOUTHWEST GAS CORPORATION
 P.O. Box 98510
 Las Vegas, Nevada 89193-8510
 Nevada Gas Tariff No. 7

Canceling 1st Revised P.U.C.N. Sheet No. 92
Original P.U.C.N. Sheet No. 92

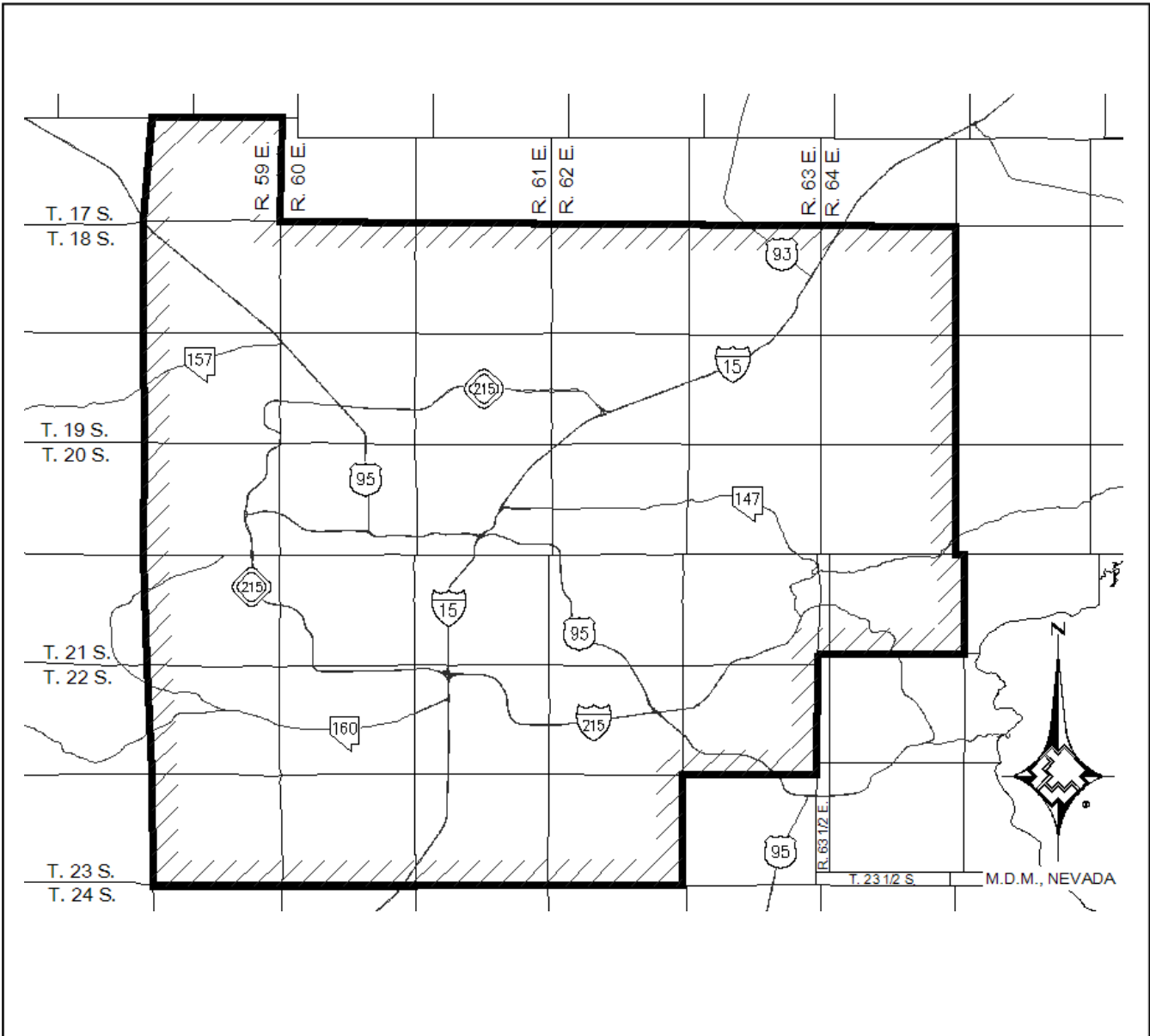

SOUTHWEST GAS CORPORATION
DISTRIBUTION SERVICE AREA
Clark County, Nevada

Issued:
 October 7, 2013

Effective:
 January 29, 2014

Advice Letter No.:

Issued by
 John P. Hester
 Senior Vice President

DESCRIPTION OF SERVICE AREA

- A. The service area of Southwest Gas Corporation lying within M.D.M., Clark County, Nevada, described as follows:
1. Township 17 South, Range 59 East.
 2. Township 18 South, Ranges 59, 60, 61, 62, 63 and 64 East.
 3. Township 19 South, Ranges 59, 60, 61, 62, 63 and 64 East.
 4. Township 20 South, Ranges 59, 60, 61, 62, 63 and 64 East.
 5. Township 21 South, Ranges 59, 60, 61, 62, 63, 63 1/2, and 64 East.
 6. Township 22 South, Ranges 59, 60, 61, 62 and 63 East.
 7. Township 23 South, Ranges 59, 60, 61 and 62 East.

<p>Issued: October 7, 2013</p> <p>Effective: January 29, 2014</p> <p>Advice Letter No.:</p>	<p>Issued by John P. Hester Senior Vice President</p>	
---	---	--

DESCRIPTION OF SERVICE AREA

(Continued)

B. The aforesaid Clark County, Nevada, service area of Southwest Gas Corporation is more particularly described as follows:

BEGINNING at the southwest (SW) corner of said Township 23 South, Range 59 East; Thence northerly along the westerly lines of said Townships 23, 22, 21, 20, 19, 18 and 17 South, Range 59 East to the northwest (NW) corner of said Township 17 South, Range 59 East; Thence easterly along the north line to the northeast (NE) corner thereof; Thence southerly along the easterly line to the southeast (SE) corner thereof; Thence easterly along the northerly lines of said Township 18 South, Ranges 60, 61, 62, 63 and 64 East to the northeast (NE) corner of said Township 18 South, Range 64 East; thence southerly along the easterly lines of said Townships 18, 19 and 20 East, Range 64 East to the southeast (SE) corner of said Township 20 South, Range 64 East, also being a point on the northerly line of said Township 21 South, Range 64 East; Thence easterly along said northerly line to the northeast (NE) corner thereof; Thence southerly along the easterly line to the southeast (SE) corner thereof; Thence westerly along the southerly line to the southwest (SW) corner thereof, also being the southeast (SE) corner of said Township 21 South, Range 63 1/2 East; Thence westerly along the southerly line to the southwest (SW) corner thereof, being a point on the east line of said Township 21 South, Range 63 East; thence southerly along the easterly lines of said Townships 21 and 22 South, Range 63 East to the southeast (SE) corner of said Township 22 South, Range 63 East; Thence westerly along the southerly line to the southwest (SW) corner thereof, also being the northeast (NE) corner of said Township 23 South, Range 62 East; Thence southerly along the easterly line to the southeast (SE) corner thereof; Thence westerly along the southerly lines of said Township 23 South, Ranges 62, 61, 60 and 59 East to the **POINT OF BEGINNING**.

<p>Issued: October 7, 2013</p> <p>Effective: January 29, 2014</p> <p>Advice Letter No.:</p>	<p>Issued by John P. Hester Senior Vice President</p>	
---	---	--

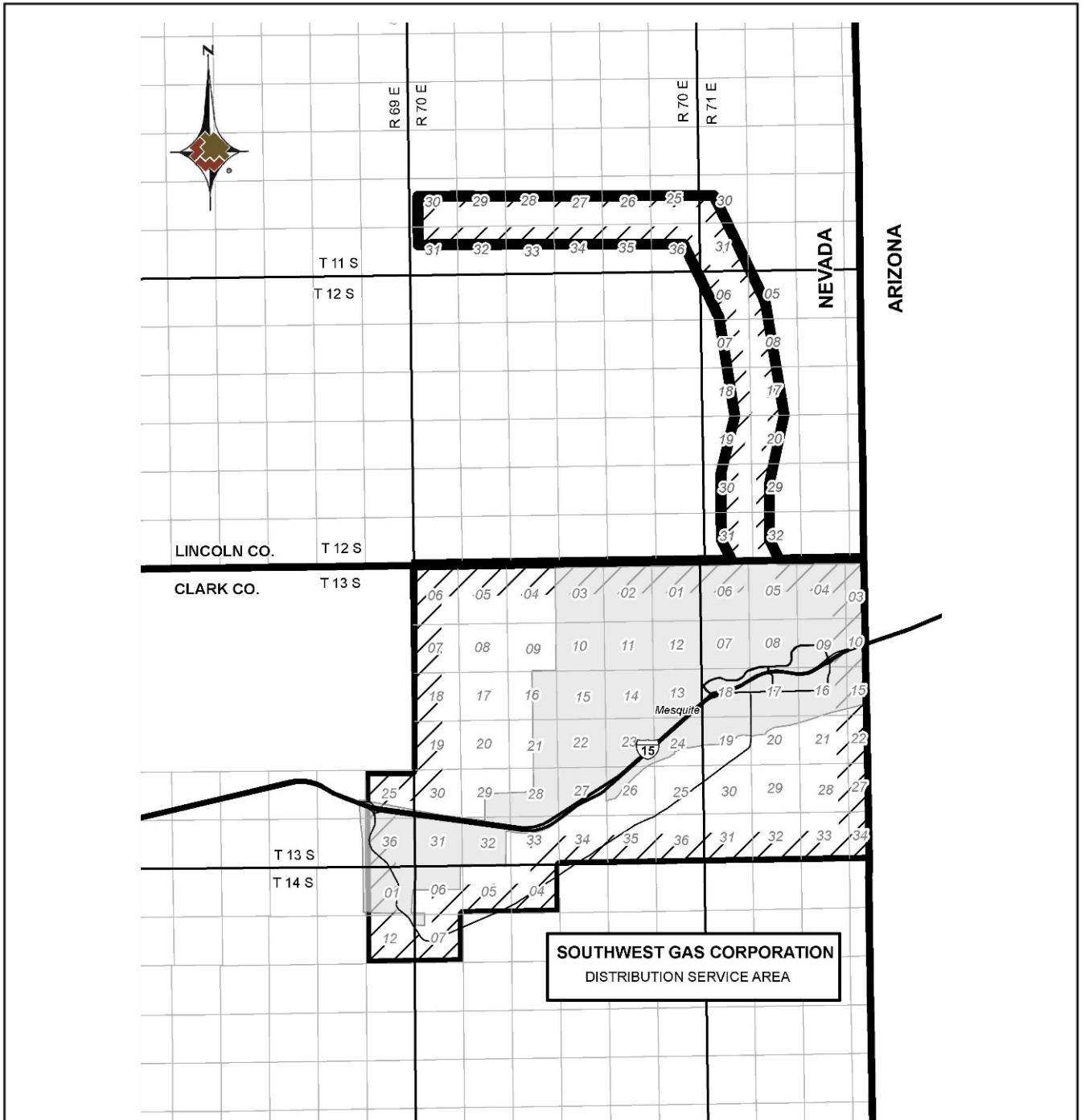

SOUTHWEST GAS CORPORATION
DISTRIBUTION SERVICE AREA

<p>Issued: November 9, 2020</p> <p>Effective: November 9, 2020</p> <p>Advice Letter No.:</p>	<p>Issued by Justin Lee Brown Senior Vice President</p>	
--	---	--

DESCRIPTION OF SERVICE AREA

The service area of Southwest Gas Corporation in or near the City of Mesquite, lying within M.D.M. Clark County, Nevada, described as follows:

1. Township 13 South, Range 69 East: All of Sections 25 and 36.
2. Township 13 South, Range 70 East: All sections.
3. Township 13 South, Range 71 East: All sections.
4. Township 14 South, Range 69 East: All of Sections 1 and 12.
5. Township 14 South, Range 70 East: All of Sections 4, 5, 6 and 7.
6. Mesquite Approach Pipeline:
A strip one (1) mile on each side of the Mesquite Approach Pipeline centerline, beginning at a point on the Kern River Pipeline within Section 30, Township 11 South, Range 70 East and running east along the Mesquite Approach Pipeline to a point on the east line of Section 25, Township 11 South, Range 70 East; thence southeasterly, along the Mesquite Approach Pipeline, through portions of Section 30 and 31, Township 11 South, Range 71 East, and Section 6, 7, 8, and 17, Township 12 South, Range 71 East to a point on Toquop Water Tank Road; Thence continuing southeasterly along said pipeline and said Toquop Water Tank Road through portions of Sections 17 and 20, Township 12 South, Range 71 East, to the intersection of Toquop Water Tank Road and Mesquite Heights Road; Thence southwesterly and southerly along said pipeline and said Mesquite Heights Road through portions of Sections 19, 20, 30, 31 and 32, Township 12 South, Range 71 East, to a point on the south line of Section 32, Township 12 South, Range 71 East, also being the county line between Lincoln County and Clark County, Nevada.

<p>Issued: November 9, 2020</p> <p>Effective: November 9, 2020</p> <p>Advice Letter No.:</p>	<p>Issued by Justin Lee Brown Senior Vice President</p>	
--	---	--

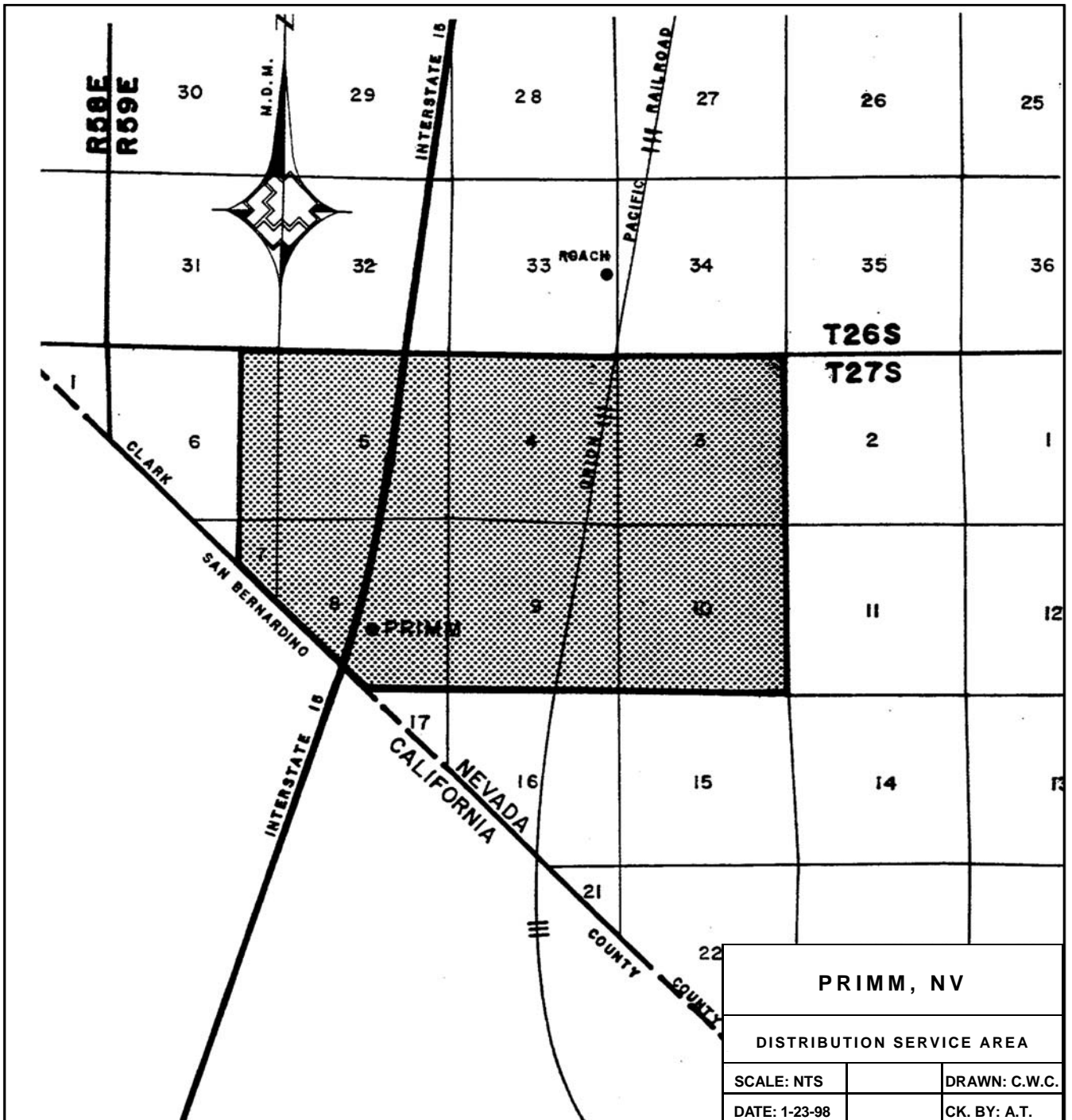

Issued:
November 10, 2009

Effective:
November 1, 2009

Advice Letter No.:

Issued by
John P. Hester
Senior Vice President

PRIMM, NV

DISTRIBUTION SERVICE AREA

SCALE: NTS		DRAWN: C.W.C.
DATE: 1-23-98		CK. BY: A.T.

DESCRIPTION OF SERVICE AREA

- A. The service area of Southwest Gas Corporation in or near Primm, County of Clark, State of Nevada, includes the following described area:

Township 27 South, Range 59 East, M.D.B.& M. All of Sections 3, 4, 5, 9 and 10; all of that portion of the east half of the east half (E $\frac{1}{2}$ E $\frac{1}{2}$) of Sections 6 and 7, and all of that portion of Section 8, northeast of the Nevada/California State Boundary Line.

- B. The aforesaid Primm, Nevada, service area of Southwest Gas Corporation is more particularly described as follows:

Beginning at the northeast (NE) corner of Section 3, Township 27 South, Range 59 East, M.D.B.& M., Clark County, Nevada; thence southerly along the east line of Sections 3 and 10, to the southeast (SE) corner of Section 10, said township and range; thence westerly along the south line of Sections 10, 9 and 8, to a point, said point being the Nevada/California State Boundary Line; thence in a northwesterly direction along said boundary line to a point, said point being the west line of the east half of the east half (E $\frac{1}{2}$ E $\frac{1}{2}$) of Section 7, said township and range; thence northerly along the west line of the east half of the east half (E $\frac{1}{2}$ E $\frac{1}{2}$) of Sections 7 and 6, to the northwest (NW) corner of said east half of the east half (E $\frac{1}{2}$ E $\frac{1}{2}$) of Section 6; thence easterly along the north line of Sections 6, 5, 4 and 3, to the northeast (NE) corner of Section 3, said township and range, said corner being the point of beginning.

<p>Issued: November 10, 2009</p> <p>Effective: November 1, 2009</p> <p>Advice Letter No.:</p>	<p>Issued by John P. Hester Senior Vice President</p>	
---	---	--

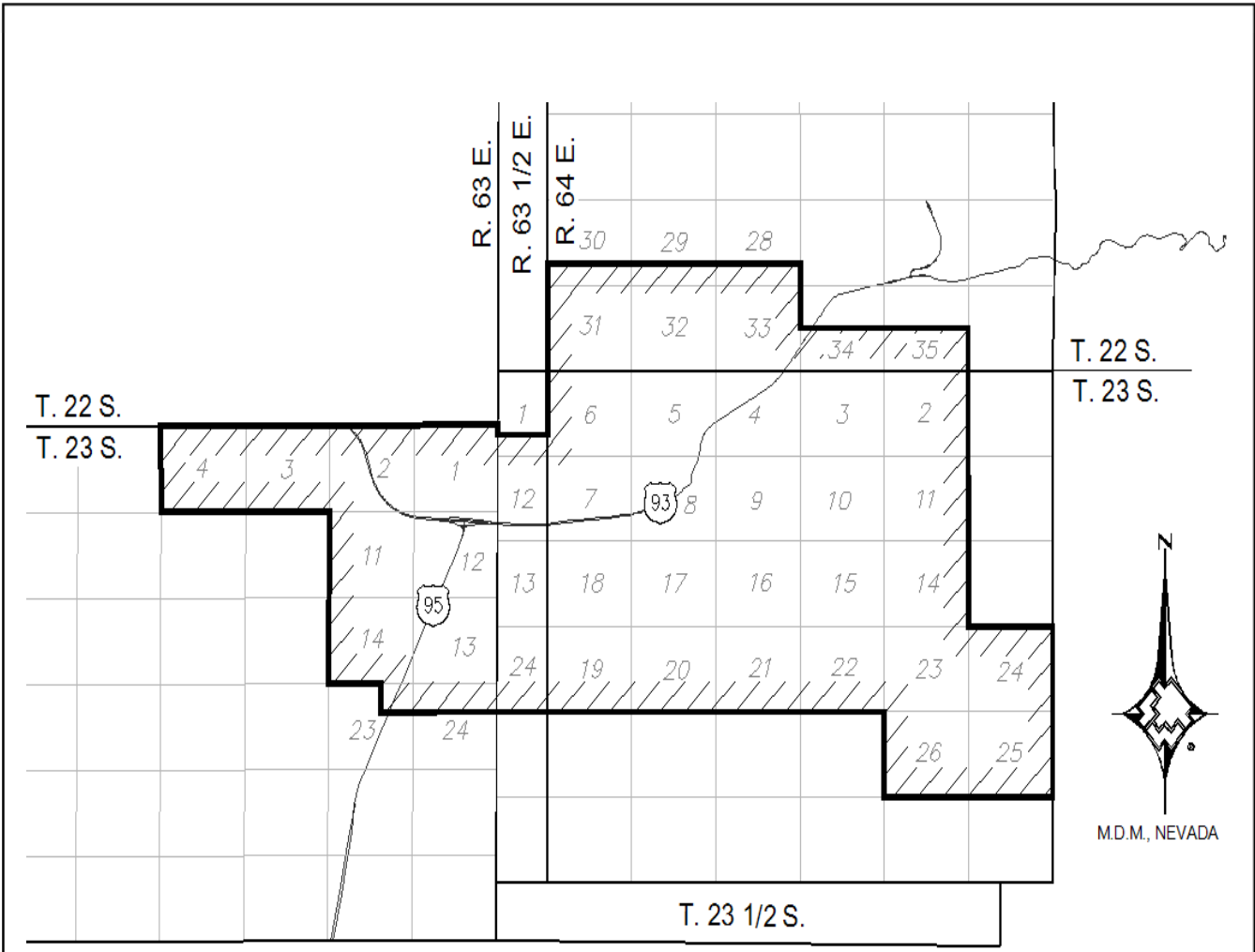

SOUTHWEST GAS CORPORATION
DISTRIBUTION SERVICE AREA
Boulder City, Nevada

Issued:
 October 7, 2013

Effective:
 January 29, 2014

Advice Letter No.:

Issued by
 John P. Hester
 Senior Vice President

DESCRIPTION OF SERVICE AREA

The service area of Southwest Gas Corporation in or near Boulder City, lying within M.D.M., Clark County, Nevada, described as follows:

1. Township 22 South, Range 64 East:
The South Half (S 1/2) of the South Half (S 1/2) of Sections 28 and 29;
The South Half (S 1/2) of the Southeast Quarter (SE 1/4), the Southeast Quarter (SE 1/4) of the Southwest Quarter (SW 1/4) and Lots 11 and 12 of Section 30;
All of Sections 31, 32 and 33; and The South Half (S 1/2) of Sections 34 and 35.
2. Township 23 South, Range 63 East: All of Sections 1, 2, 3, 4, 11, 12, 13 and 14;
The Northeast Quarter (NE 1/4) of the Northeast Quarter (NE 1/4) and all of Lots 1, 4 and 5 of Section 23; and
The North Half (N 1/2) of the North Half (N 1/2) and all of Lots 1, 2, 3 and 4 of Section 24.
3. Township 23 South, Range 63-1/2 East: All of Lots 8, 9, and 10 of Section 1; and
All of Sections 12, 13 and 24.
4. Township 23 South, Range 64 East: All of Sections 2, 3, 4, 5, 6, 7, 8, 9, 10, 11, 14, 15, 16, 17, 18, 19, 20, 21, 22, 23, 24, 25 and 26.

<p>Issued: October 7, 2013</p> <p>Effective: January 29, 2014</p> <p>Advice Letter No.:</p>	<p>Issued by John P. Hester Senior Vice President</p>	
---	---	--

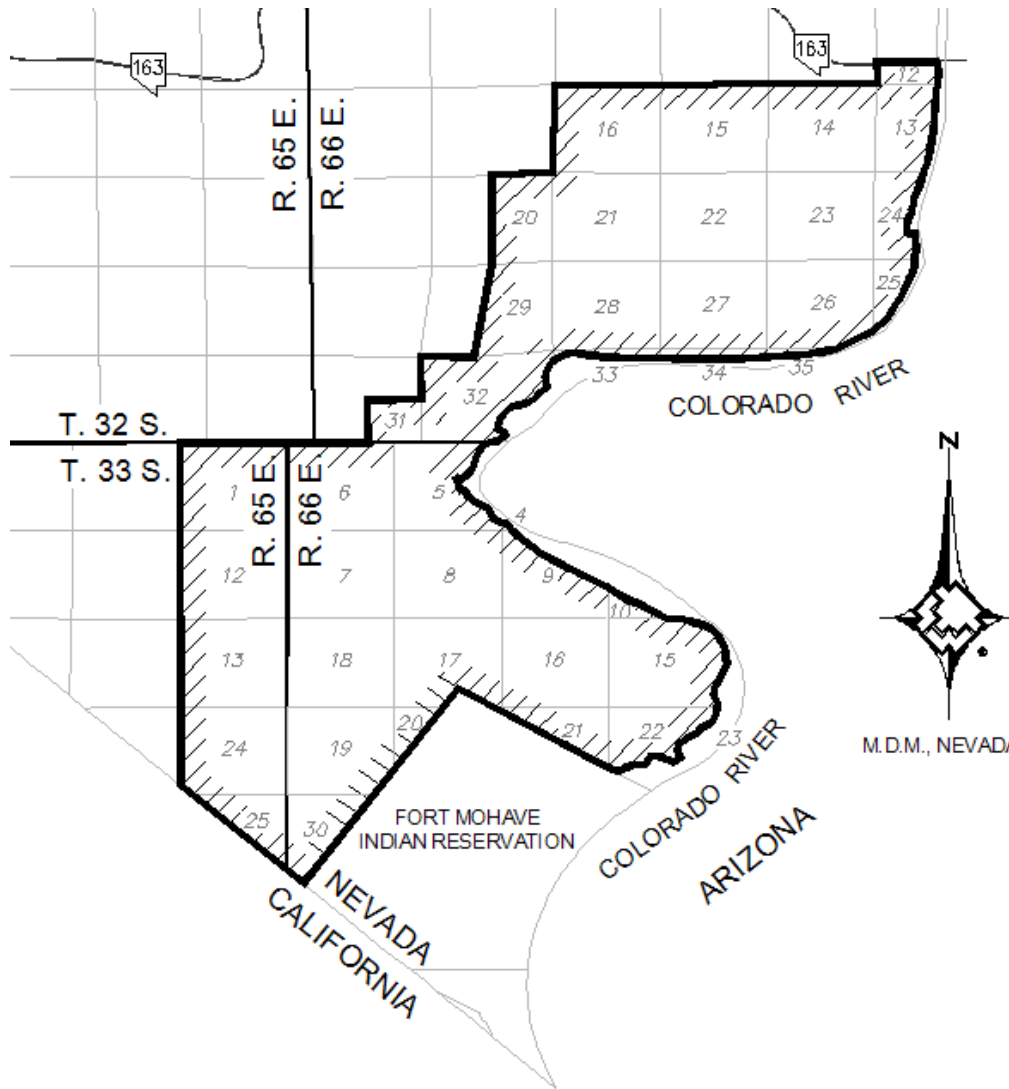

SOUTHWEST GAS CORPORATION
DISTRIBUTION SERVICE AREA
FORT MOHAVE, NEVADA

Issued:
October 7, 2013

Effective:
January 29, 2014

Advice Letter No.:

Issued by
John P. Hester
Senior Vice President

DESCRIPTION OF SERVICE AREA

A. The service area of Southwest Gas Corporation in or near Fort Mohave, lying within M.D.M., Clark County, Nevada, described as follows:

1. Township 32 South, Range 66 East.
All of Lots 14, 15 and 16 of Section 12;
The East Half (E 1/2) of Sections 20 and 29;
Thence Southeast Quarter (SE 1/4) of Section 31; and
All of Sections 13, 14, 15, 16, 21, 22, 23, 24, 25, 26, 27, 28, 32, 33, 34 and 35.
2. Township 33 South, Range 65 East.
All of Sections 1, 12, 13, 24 and 25;
3. Township 33 South, Range 66 East.
All of Sections 4, 5, 6, 7, 8, 9, 10, 15, 16, 17, 18, 19, 20, 21, 22 and 30.
Excepting therefrom any portion lying within the Fort Mohave Indian Reservation.

B. The aforesaid Fort Mohave, Nevada, service area of Southwest Gas Corporation is more particularly described as follows:

BEGINNING at the northwest (NW) corner of said Section 1, Township 33 South, Range 65 East; thence southerly along the westerly lines of Sections 1, 12, 13 and 24 of said Township and Range to the Nevada-California State boundary in said Section 24; Thence southeasterly along said State boundary to the northwesterly boundary of Fort Mohave Indian Reservation within said Section 30, Township 33 South, Range 66 East; Thence northeasterly along said northwesterly boundary to the most northerly corner of said Fort Mohave Indian Reservation within said Section 17, Township 33 South, Range 66 East; Thence southeasterly along the northeasterly boundary thereof to the Nevada-Arizona State boundary; Thence in a northerly direction along said Nevada-Arizona State boundary within said Townships 33 and 32 South, Range 66 East to the northeast (NE) corner of said Lot 16 of Section 12, Township 32 South, Range 66 East; Thence westerly along

<p>Issued: October 7, 2013</p> <p>Effective: January 29, 2014</p> <p>Advice Letter No.:</p>	<p>Issued by John P. Hester Senior Vice President</p>	
---	---	--

DESCRIPTION OF SERVICE AREA
(CONTINUED)

the northerly lines of said Lots 16, 15 and 14 of said Section 12 to the northwest (NW) corner of said Lot 14; Thence southerly along the westerly line to the southwest (SW) corner thereof, also being the northeast (NE) corner of said Section 14 of said Township and Range; Thence westerly along the northerly lines of said Sections 14, 15 and 16 of said Township and Range to the northwest (NW) corner of said Section 16; Thence southerly along the westerly line to the southwest (SW) corner thereof, also being the northeast (NE) corner of said Section 20 of said Township and Range; Thence westerly along the northerly line of said Section 20 to the north quarter (N 1/4) corner thereof; Thence southerly along the north/south center section lines of said Sections 20 and 29 of said Township and Range to the south quarter (S 1/4) corner of said Section 29; Thence westerly along the southerly line to the southwest (SW) corner thereof, also being the northeast (NE) corner of said Section 31 of said Township and Range; Thence southerly along the easterly line of said Section 31 to the east quarter (E 1/4) corner thereof; Thence westerly along the northerly line of the southeast quarter (SE 1/4) thereof to the northwest (NW) corner thereof; thence southerly along the westerly line thereof to the south quarter (S 1/4) corner thereof, being a point on the northerly line of said Section 6, Township 33 South, Range 66 East; Thence westerly along the northerly line of said Section 6 to the northwest (NW) corner thereof, also being northeast (NE) corner of said Section 1, Township 33 South, Range 65 East; Thence westerly along the northerly line of said Section 1 to the **POINT OF BEGINNING**.

<p>Issued: October 7, 2013 Effective: January 29, 2014 Advice Letter No.:</p>	<p>Issued by John P. Hester Senior Vice President</p>	
---	---	--

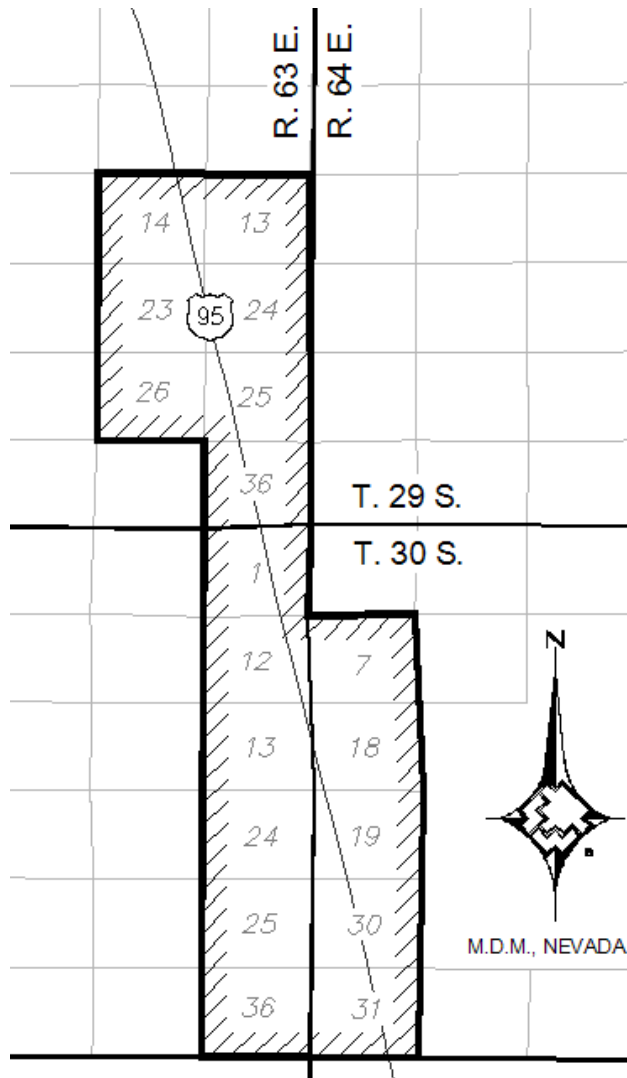

SOUTHWEST GAS CORPORATION

**DISTRIBUTION
 SERVICE AREA**

Cal-Nev-Ari, Nevada

Issued:
 October 7, 2013

Effective:
 January 29, 2014

Advice Letter No.:

Issued by
 John P. Hester
 Senior Vice President

DESCRIPTION OF SERVICE AREA

- A. The service area of Southwest Gas Corporation in or near Cal-Nev-Ari, lying within M.D.M., Clark County, Nevada, described as follows:
1. Township 29 South, Range 63 East:
All of Sections 13, 14, 23, 24, 25, 26 and 36.
 2. Township 30 South, Range 63 East:
All of Sections 1, 12, 13, 24, 25 and 36.
 3. Township 30 South, Range 64 East:
All of Sections 7, 18, 19, 30 and 31.

Issued:
October 7, 2013

Effective:
January 29, 2014

Advice Letter No.:

Issued by
John P. Hester
Senior Vice President

SOUTHWEST GAS CORPORATION
 P.O. Box 98510
 Las Vegas, Nevada 89193-8510
 Nevada Gas Tariff No. 7

Original _____ P.U.C.N. Sheet No. 103
 Canceling _____ P.U.C.N. Sheet No. _____

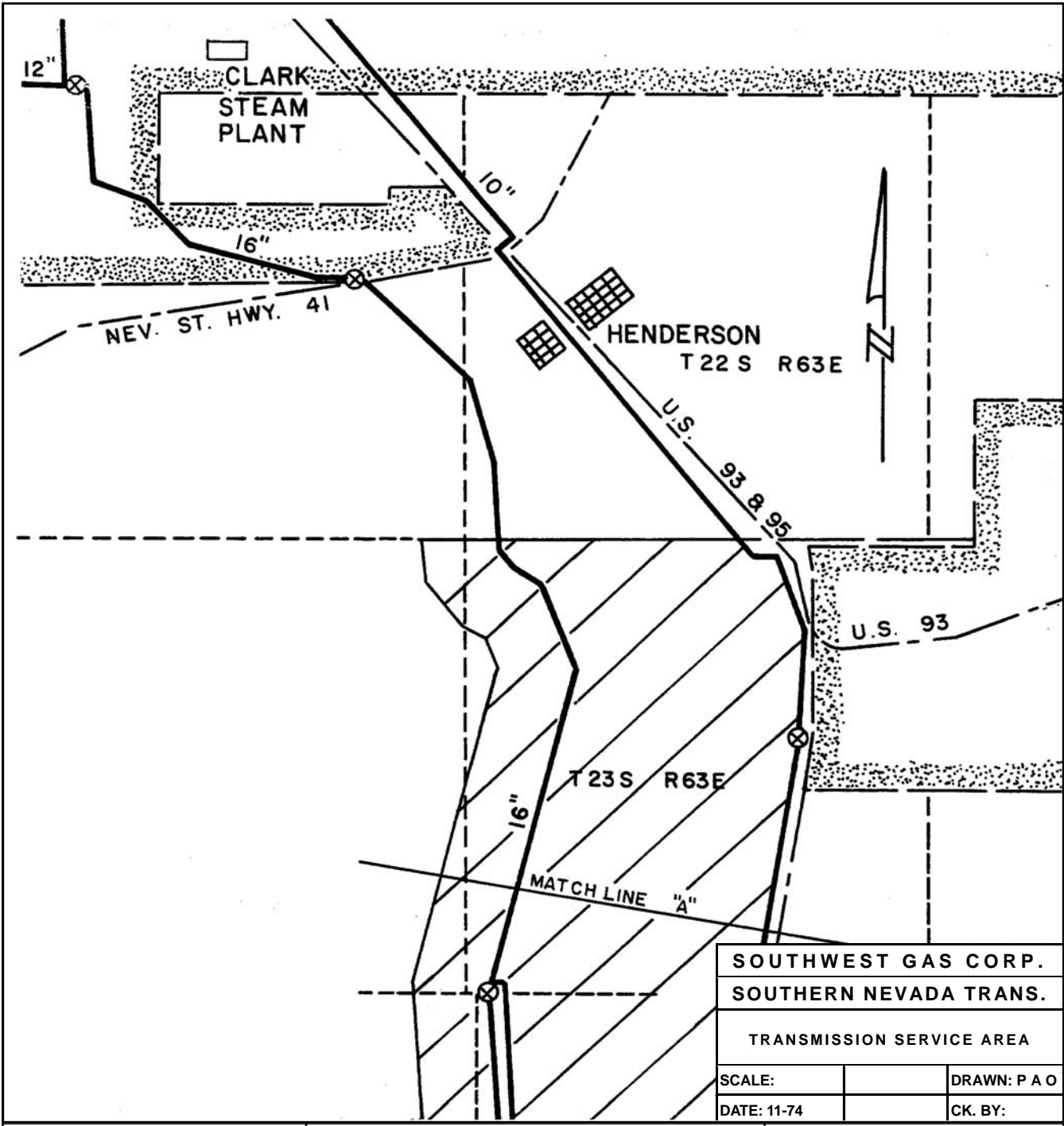

SOUTHWEST GAS CORP.		
SOUTHERN NEVADA TRANS.		
TRANSMISSION SERVICE AREA		
SCALE:		DRAWN: P A O
DATE: 11-74		CK. BY:

Issued:
 November 10, 2009

Effective:
 November 1, 2009

Advice Letter No.:

Issued by
 John P. Hester
 Senior Vice President

SOUTHWEST GAS CORPORATION
 P.O. Box 98510
 Las Vegas, Nevada 89193-8510
 Nevada Gas Tariff No. 7

Original _____ P.U.C.N. Sheet No. 104
 Canceling _____ P.U.C.N. Sheet No. _____

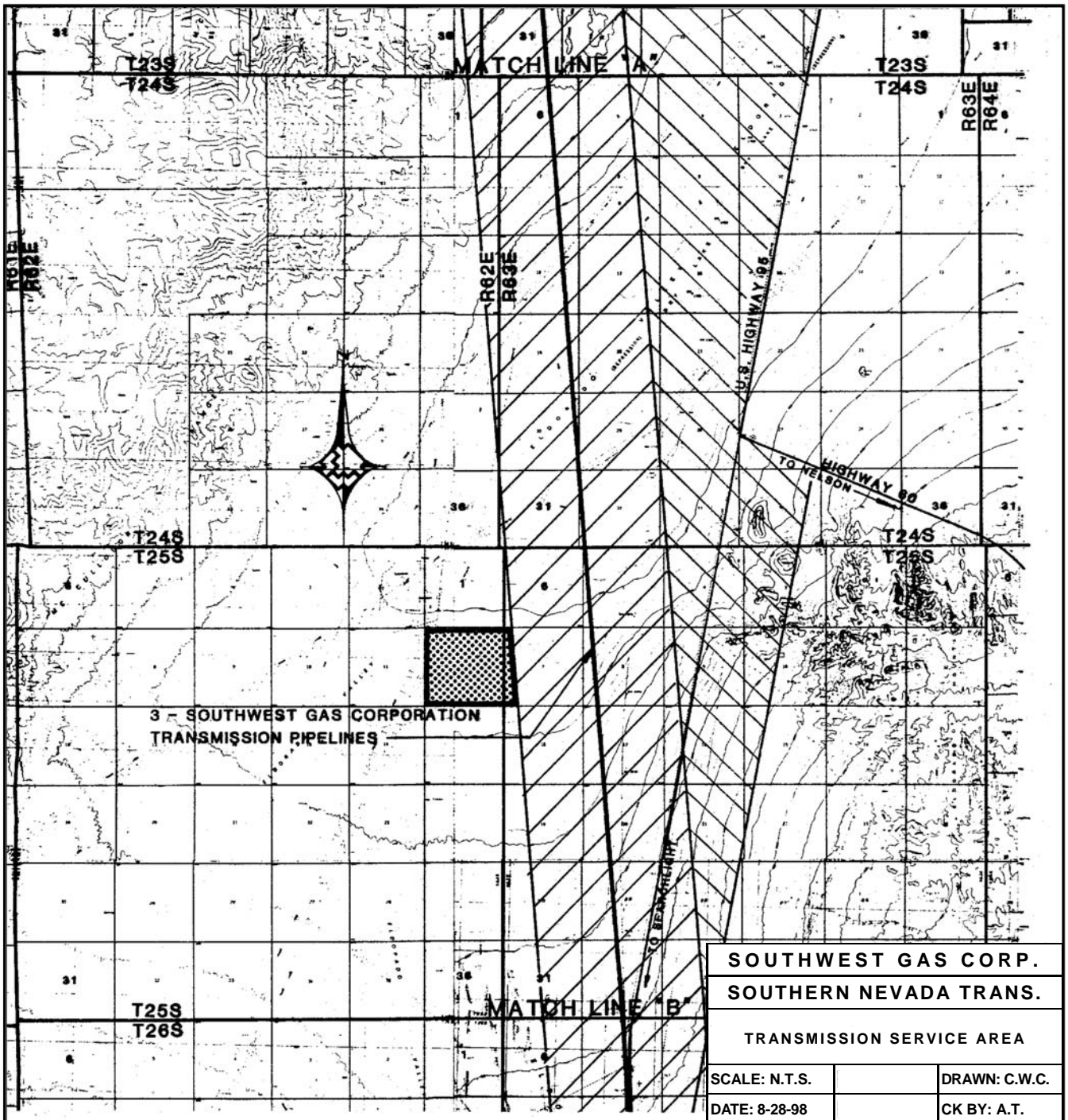

SOUTHWEST GAS CORP.	
SOUTHERN NEVADA TRANS.	
TRANSMISSION SERVICE AREA	
SCALE: N.T.S.	DRAWN: C.W.C.
DATE: 8-28-98	CK BY: A.T.

<p>Issued: November 10, 2009</p>	<p>Issued by John P. Hester Senior Vice President</p>
<p>Effective: November 1, 2009</p>	
<p>Advice Letter No.:</p>	

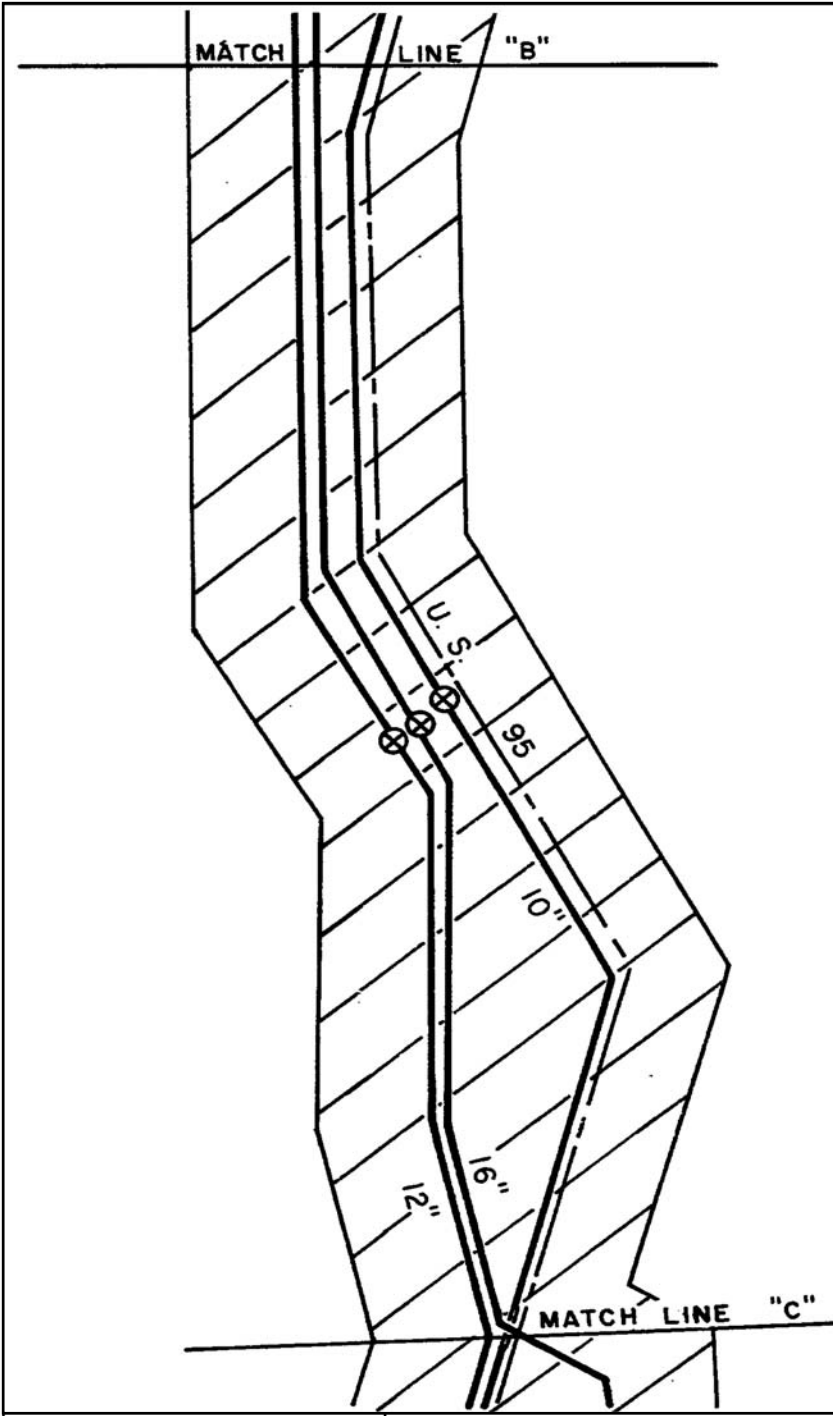

SOUTHWEST GAS CORP.		
SOUTHERN NEVADA TRANS.		
TRANSMISSION SERVICE AREA		
SCALE:		DRAWN: P A O
DATE: 11-74		CK. BY:

<p>Issued: November 10, 2009</p> <p>Effective: November 1, 2009</p> <p>Advice Letter No.:</p>	<p>Issued by John P. Hester Senior Vice President</p>	
---	---	--

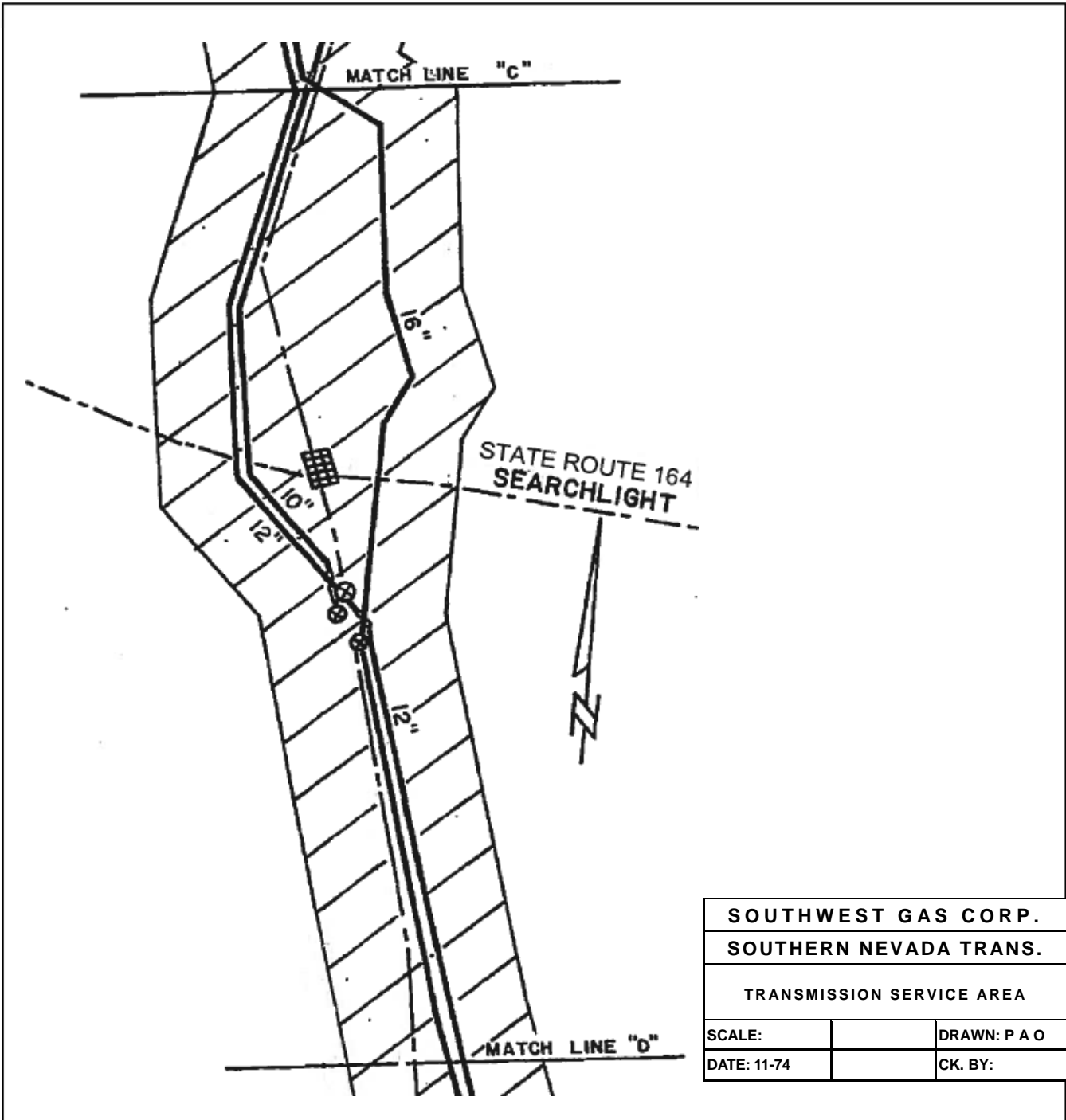

SOUTHWEST GAS CORP.		
SOUTHERN NEVADA TRANS.		
TRANSMISSION SERVICE AREA		
SCALE:		DRAWN: P A O
DATE: 11-74		CK. BY:

Issued:
 October 7, 2013

Effective:
 January 29, 2014

Advice Letter No.:

Issued by
 John P. Hester
 Senior Vice President

SOUTHWEST GAS CORPORATION
 P.O. Box 98510
 Las Vegas, Nevada 89193-8510
 Nevada Gas Tariff No. 7

Canceling 1st Revised P.U.C.N. Sheet No. 107
Original P.U.C.N. Sheet No. 107

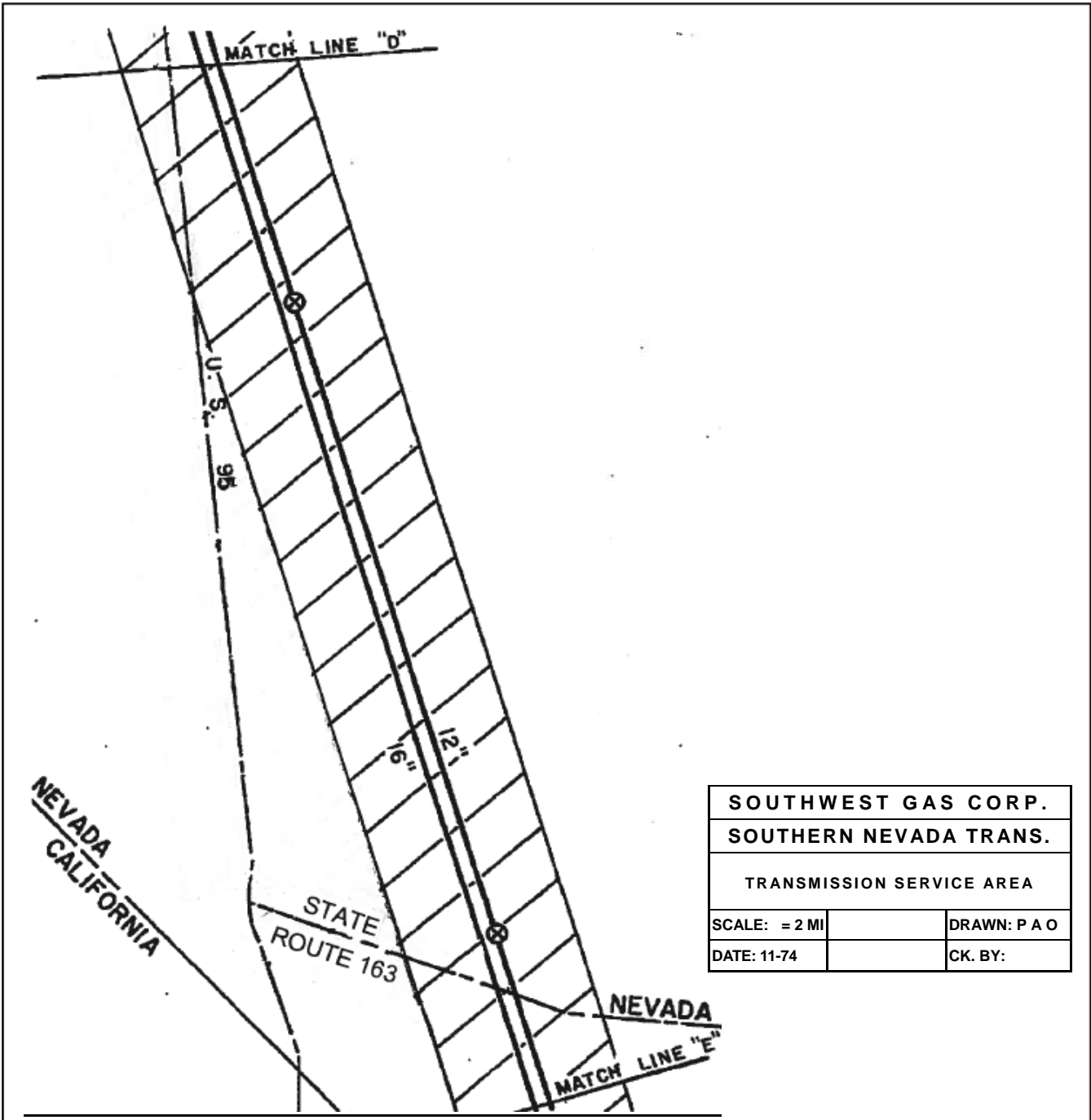

SOUTHWEST GAS CORP.		
SOUTHERN NEVADA TRANS.		
TRANSMISSION SERVICE AREA		
SCALE: = 2 MI		DRAWN: P A O
DATE: 11-74		CK. BY:

<p>Issued: October 7, 2013</p> <p>Effective: January 29, 2014</p> <p>Advice Letter No.:</p>	<p>Issued by John P. Hester Senior Vice President</p>	
---	---	--

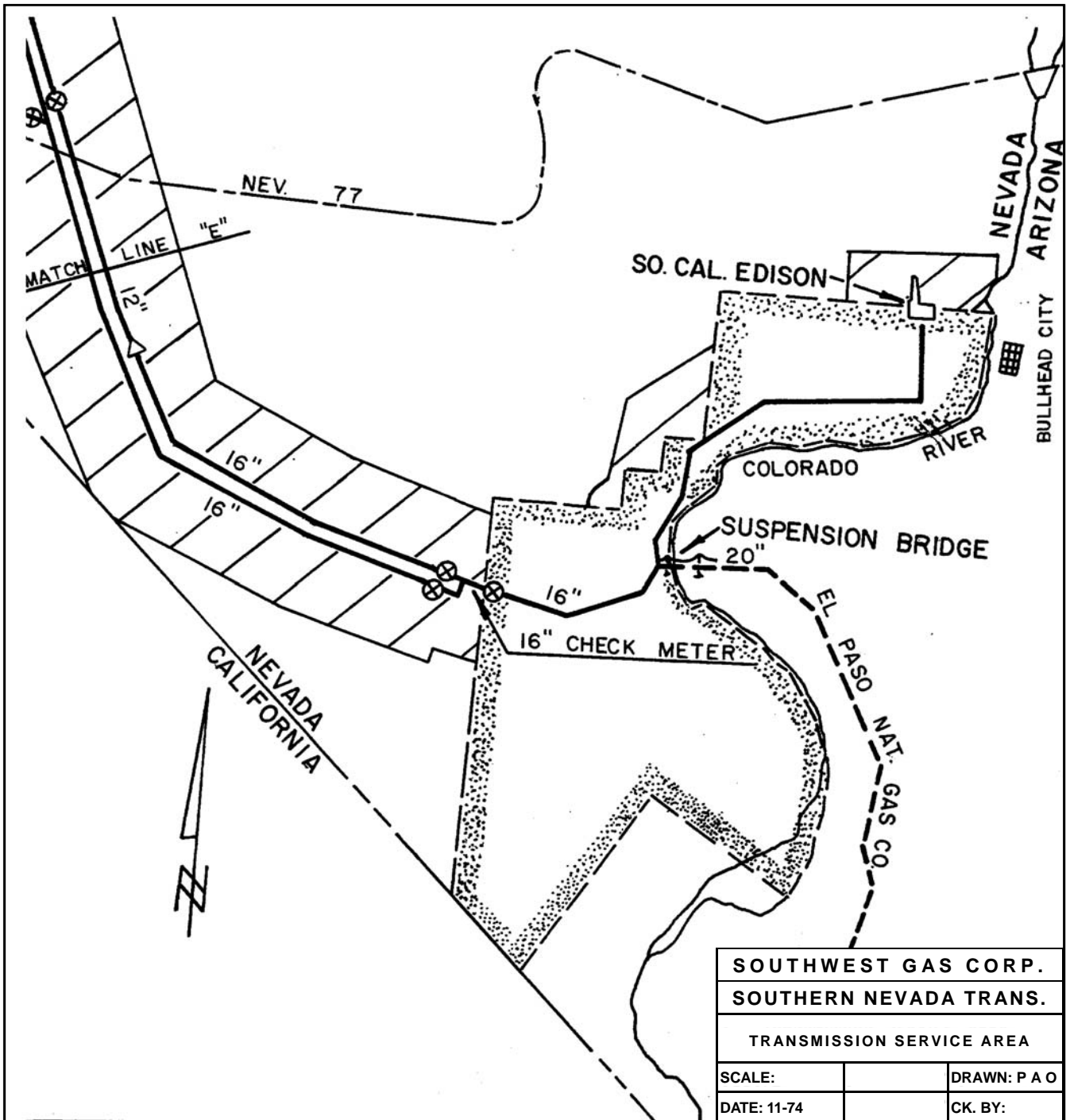

SOUTHWEST GAS CORP.		
SOUTHERN NEVADA TRANS.		
TRANSMISSION SERVICE AREA		
SCALE:		DRAWN: P A O
DATE: 11-74		CK. BY:

<p>Issued: November 10, 2009</p> <p>Effective: November 1, 2009</p> <p>Advice Letter No.:</p>	<p>Issued by John P. Hester Senior Vice President</p>	
---	---	--

DESCRIPTION OF SERVICE AREA

A. The service area of Southwest Gas Corporation lying within M.D.M., Clark County, Nevada, along its main transmission pipeline and lateral pipelines, described as follows:

1. Main Lines

A strip one (1) mile on the east side of the most easterly pipeline, one (1) mile on the west side of the most westerly pipeline and including all the area between said pipelines, beginning at a point on the Colorado River in Section 4, Township 33 South, Range 66 East and continuing along the main transmission pipelines to the south line of Township 22 South, Ranges 62 and 63 East, near Henderson, Nevada.

Excepting therefrom, commencing in Section 27, Township 24 South, Range 63 East, the strip on the east side of the most easterly pipeline will stop at the centerline of U.S. Highway 95 and State Route 165 (formerly State Highway 60) and will continue northerly along the centerline of U.S. Highway 95 to the south line of Township 22 South, Range 63 East, near Henderson, Nevada.

All of those portions of Sections 6 and 7, Township 25 South, Range 63 East and all of Sections 1 and 12, Township 25 South, Range 62 East, west of the existing main transmission pipelines.

2. Edison Lateral

A strip one (1) mile on each side of the Edison Lateral centerline, beginning at a point on the main transmission pipeline within Section 5, Township 33 South, Range 66 East and continuing along the pipeline centerline to the termination point in Section 23, Township 32 South, Range 66 East.

<p>Issued: October 7, 2013</p> <p>Effective: January 29, 2014</p> <p>Advice Letter No.:</p>	<p>Issued by John P. Hester Senior Vice President</p>	
---	---	--

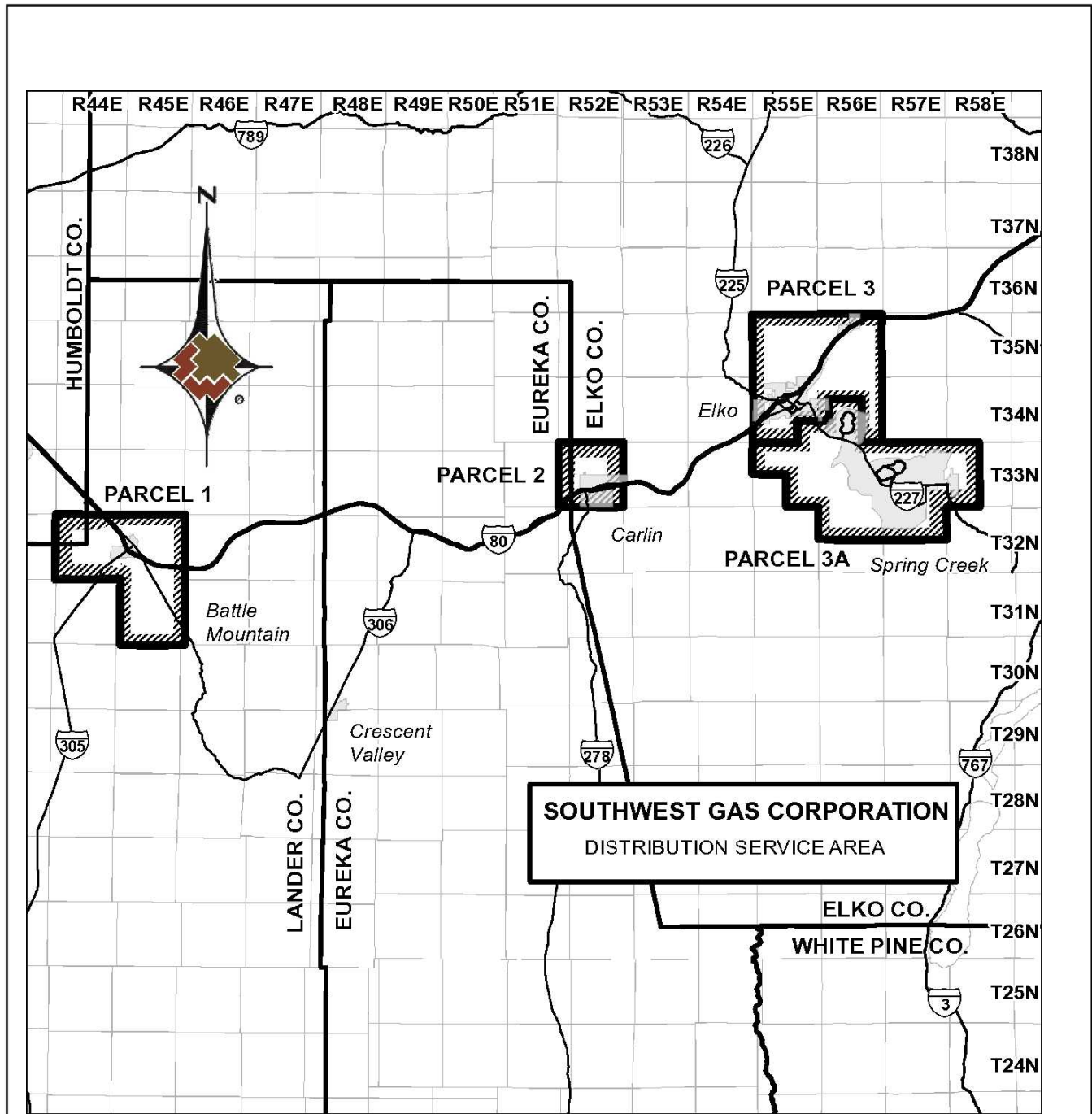

Issued:
 December 16, 2020

Effective:
 December 18, 2020

Advice Letter No.:

Issued by
 Justin Lee Brown
 Senior Vice President

DESCRIPTION OF SERVICE AREA

- A. The service area of Southwest Gas Corporation in the Counties of Humboldt, Elko, and Lander, State of Nevada, includes the following described area:
1. Township 35 North, Range 55 East, M.D.B.& M. All sections.
 2. Township 35 North, Range 56 East, M.D.B.& M. All sections.
 3. Township 34 North, Range 55 East. M.D.B.& M. All sections.
 4. Township 34 North, Range 56 East. M.D.B.& M. All sections.
 5. Township 33 North, Range 52 East, M.D.B.& M. All sections.
 6. Township 33 North, Range 55 East, M.D.B & M. All of Sections 1, 2, 3, 4, 5, 6, 7, 8, 9, 10, 11, 12, 13, 14, 15, 16, 17, 18, 22, 23, 24, 25, 26, 27, 34, 35 and 36.
 7. Township 33 North, Range 56 East, M.D.B.& M. All sections.
 8. Township 33 North, Range 57 East, M.D.B.& M. All sections.
 9. Township 33 North, Range 58 East, M.D.B.& M. All of Sections 4, 5, 6, 7, 8, 9, 16, 17, 18, 19, 20, 21, 28, 29, 30, 31, 32 and 33.
 10. Township 32 North, Range 44 East, M.D.B.& M. All sections.
 11. Township 32 North, Range 45 East, M.D.B.& M. All sections.
 12. Township 32 North, Range 56 East, M.D.B. & M. All of Sections 1, 2, 3, 4, 5, 6, 7, 8, 9, 10, 11, 12, 13, 14, 15, 16, 17 and 18.
 13. Township 32 North, Range 57 East, M.D.B. & M. All of Sections 1, 2, 3, 4, 5, 6, 7, 8, 9, 10, 11, 12, 13, 14, 15, 16, 17 and 18.
 14. Township 31 North, Range 45 East, M.D.B.& M. All sections.

<p>Issued: <p style="text-align: center;">January 2, 2020</p> <p>Effective: <p style="text-align: center;">January 2, 2020</p> <p>Advice Letter No.:</p> </p></p>	<p style="text-align: center;">Issued by Justin Lee Brown Senior Vice President</p>	
---	---	--

N
N
T
T
N
N
T
L
L

T

DESCRIPTION OF SERVICE AREA
(Continued)

B. The aforesaid service area of Southwest Gas Corporation is more particularly described as follows:

PARCEL 1: Beginning at the northwest (NW) corner of Section 6, Township 32 North, Range 44 East, M.D.B.& M., Humboldt County, Nevada; thence easterly along the north lines of Township 32 North, Ranges 44 and 45 East, crossing into Lander County, to the northeast (NE) corner of Section 1, Township 32 North, Range 45 East; thence southerly along the east lines of Townships 32 and 31 North, Range 45 East to the southeast (SE) corner of Section 36, Township 31 North, Range 45 East; thence westerly along the south lines of Sections 36, 35, 34, 33, 32 and 31 to the southwest (SW) corner of Section 31, said Township and Range; thence northerly along the west lines of Sections 31, 30, 19, 18, 7 and 6 to the northwest (NW) corner of Section 6, said Township and Range; thence westerly along the south lines of Sections 36, 35, 34, 33, 32 and 31 to the southwest (SW) corner of Section 31, Township 32 North, Range 44 East; thence northerly along the west lines of Sections 31, 30, 19, 18, 7 and 6, crossing into Humboldt County, to the northwest (NW) corner of Section 6, Township 32 North, Range 44 East, the point of beginning.

PARCEL 2: Beginning at the northwest (NW) corner of Section 6, Township 33 North, Range 52 East, M.D.B.& M., Elko County, Nevada; thence easterly along the north lines of Sections 6, 5, 4, 3, 2 and 1 to the northeast (NE) corner of Section 1, said Township and Range; thence southerly along the east lines of Sections 1, 12, 13, 24, 25 and 36 to the southeast (SE) corner of Section 36, said Township and Range; thence westerly along the south lines of Sections 36, 35, 34, 33, 32 and 31 to the southwest (SW) corner of Section 31, said Township and Range; thence northerly along the west lines of Sections 31, 30, 19, 18, 7 and 6 to the northwest (NW) corner of Section 6, Township 33 North, Range 52 East, the point of beginning.

<p>Issued: January 2, 2020</p> <p>Effective: January 2, 2020</p> <p>Advice Letter No.:</p>	<p style="text-align: center;">Issued by Justin Lee Brown Senior Vice President</p>	
--	---	--

DESCRIPTION OF SERVICE AREA

(Continued)

B. PARCEL 3: Beginning at the northwest (NW) corner of Section 6, Township 35 North, Range 55 East, M.D.B.& M., Elko County, Nevada; thence easterly along the north lines of Township 35 North, Ranges 55 and 56 East to the northeast (NE) corner of Section 1, Township 35 North, Range 56 East; thence southerly along the east lines of Townships 35 and 34 North, Range 56 East to the southeast (SE) corner of Section 36, Township 34 North, Range 56 East; thence westerly along the south lines of Sections 36 and 35, Township 34 North, Range 56 East to the southwest (SW) corner of Section 35 said Township and Range; thence northerly along the west line of Sections 35, 26, 23 and 14, Township 34 North, Range 56 East to the northwest (NW) corner of Section 14, said Township and Range; thence westerly along the south lines of Section 10, 9, and 8, Township 34N, Range 56 East to the southwest (SW) corner of Section 8, said Township and Range; thence southerly along the east lines of Sections 18 and 19, Township 34 North, Range 56 East to the southeast (SE) corner of Section 19, said Township and Range; thence westerly along the south line of Section 19, Township 34 North, Range 56 East and the south lines of Sections 24 and 23, Township 34 North, Range 55 East to the southwest (SW) corner of Section 23, Township 34 North, Range 55 East; thence southerly along the east lines of Section 27 and 34, Township 34 North, Range 55 East to the southeast (SE) corner of Section 34 said Township and Range; thence westerly along the south lines of Sections 34, 33, 32 and 31, Township 34 North, Range 55 East, to the southwest (SW) corner of Section 31, said Township and Range; thence northerly along the west lines of Townships 34 and 35 North, Range 55 East to the northwest (NW) corner of Section 6, Township 35 North, Range 55 East, the point of beginning.

PARCEL 3A ("Spring Creek Expansion Area") : Beginning at the northwest (NW) corner of Section 6, Township 33 North, Range 55 East, M.D.B.& M., Elko County Nevada; thence easterly along the north lines of Sections 6, 5, 4 and 3, Township 33 North, Range 55 East, to the northeast (NE) corner of Section 3, said Township and Range; thence northerly along the west lines of Sections 35 and 26, Township 34 North, Range 55 East, to the northwest (NW) corner of Section 26, said Township and Range; thence easterly along the north lines of Sections 26 and 25, Township 34 North, Range 55 East and Section 30, Township 34 North, Range 56

<p>Issued: December 16, 2020</p> <p>Effective: December 18, 2020</p> <p>Advice Letter No.:</p>	<p>Issued by Justin Lee Brown Senior Vice President</p>	
--	---	--

DESCRIPTION OF SERVICE AREA
(Continued)

PARCEL 3A (cont): East to the northeast (NE) corner of Section 30, Township 34 North, Range 56 East; thence northerly along the west lines of Sections 20 and 17, Township 34 North, Range 56 East to the northwest (NW) corner of Section 17, said Township and Range; thence easterly along the north lines of Sections 17, 16 and 15, Township 34 North, Range 56 East to the northeast (NE) corner of Section 15, said Township and Range; thence southerly along the east lines of Sections, 15, 22, 27 and 28, Township 34 North, Range 56 East, to the southeast (SE) corner of Section 28, said Township and Range; thence easterly along the north lines of Sections 2 and 1, Township 33 North, Range 56 East to the northeast (NE) corner of Section 1, said Township and Range; thence continuing easterly along the north lines of Township 33 North, Ranges 57 and 58 East to the northeast (NE) corner of Section 4, Township 33 North, Range 58 East; thence southerly along the east lines of Sections 4, 9, 16, 21, 28 and 33, Township 33 North, Range 58 East, to the southeast corner of Section 33, said Township and Range; thence westerly along the south lines of Sections 33, 32 and 31 of Township 33 North, Range 58 East to the southwest (SW) corner of Section 31, said Township and Range; thence southerly along the east lines of Sections 1, 12 and 13, Township 32 North, Range 57 East to the southeast corner of Section 13, said Township and Range; thence westerly along the south lines of Sections 13, 14, 15, 16, 17 and 18, Township 32 North, Range 57 East to the southwest (SW) corner of Section 18, said Township and Range; thence westerly along the south lines of Sections 13, 14, 15, 16, 17 and 18 of Township 32 North, Range 56 East to the southwest (SW) corner of Section 18, said Township and Range; thence northerly along the west lines of Sections 18, 7 and 6, Township 32 North, Range 56 East to the northwest (NW) corner of Section 6, said Township and Range; thence westerly along the south lines of Sections 36, 35 and 34 of Township 33 North, Range 55 East to the southwest (SW) corner of Section 34, said Township and Rang; thence northerly along the west lines of Sections 34, 27 and 22, Township 33 North, Range 55 East to the northwest (NW) corner of Section 22, said Township and Range; thence westerly along the south lines of Sections 16, 17 and 18, Township 33 North, Range 55 East to the southwest (SW) corner of Section 18, said Township and Range; thence northerly along the west lines of Sections 18, 7 and 6, Township 33 North, Range 55 East to the northwest (NW) corner of Section 6, said Township and Range, the point of beginning.

<p>Issued: December 16, 2020</p> <p>Effective: December 18, 2020</p> <p>Advice Letter No.:</p>	<p align="center">Issued by Justin Lee Brown Senior Vice President</p>	
--	--	--

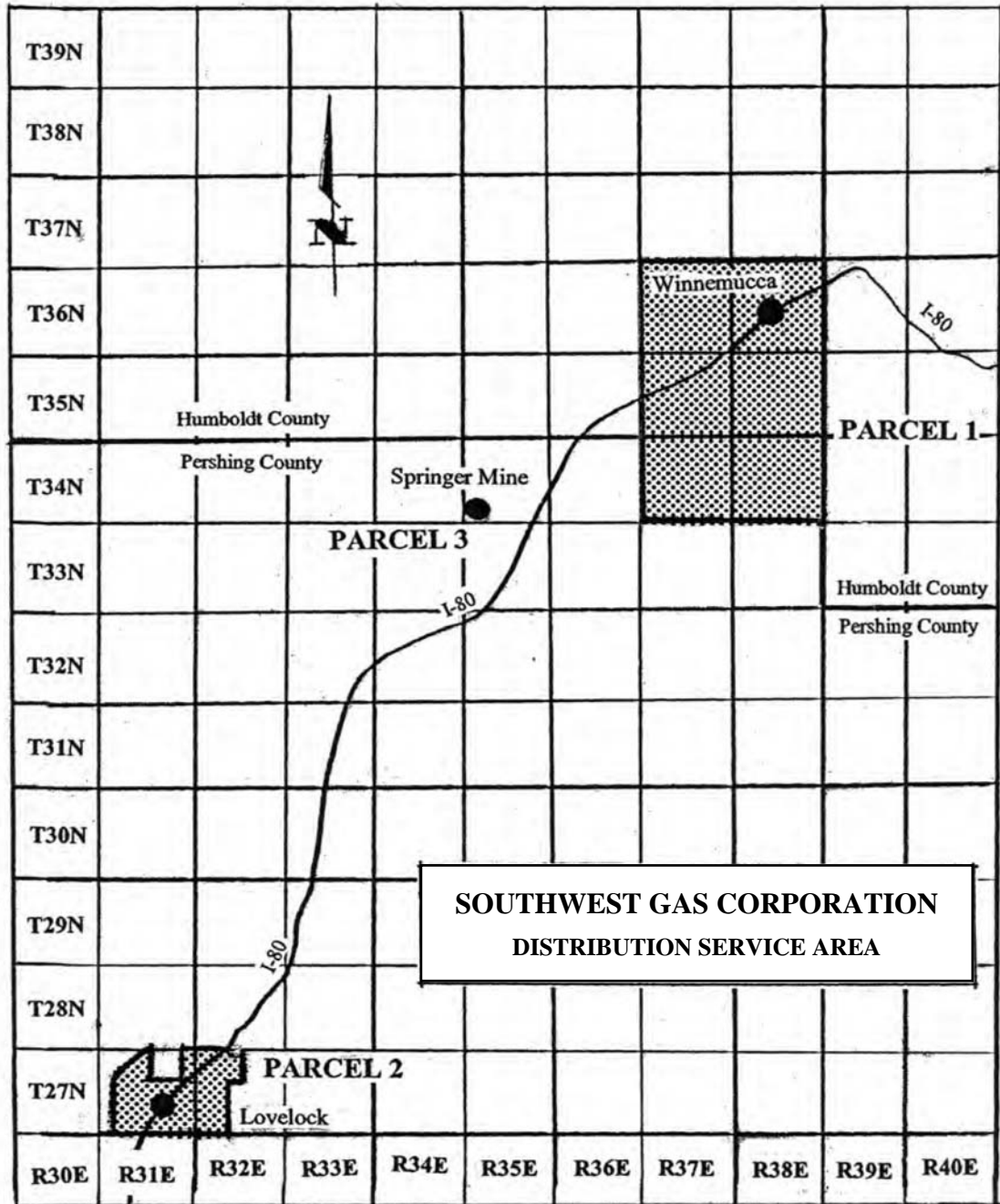

**SOUTHWEST GAS CORPORATION
DISTRIBUTION SERVICE AREA**

Issued:
November 10, 2009

Effective:
November 1, 2009

Advice Letter No.:

Issued by
John P. Hester
Senior Vice President

DESCRIPTION OF SERVICE AREA

- A. The service area of Southwest Gas Corporation in the Counties of Humboldt and Pershing, State of Nevada, includes the following described area:
1. Township 36 North, Range 37 East, M.D.B.& M. All sections.
 2. Township 36 North, Range 38 East, M.D.B.& M. All sections.
 3. Township 35 North, Range 37 East, M.D.B.& M. All sections.
 4. Township 35 North, Range 38 East, M.D.B.& M. All sections.
 5. Township 34 North, Range 37 East, M.D.B.& M. All sections.
 6. Township 34 North, Range 38 East, M.D.B.& M. All sections.
 7. Township 26 North, Range 31 East, M.D.B.& M. All of Sections 1, 2, 3, 4 and 5.
 8. Township 26 North, Range 32 East, M.D.B.& M. All of Sections 5 and 6.
 9. Township 27 North, Range 31 East, M.D.B.& M. All of Sections 1, 12, 13, 16, 20, 21, 22, 23, 24, 25, 26, 27, 28, 29, 32, 33, 34, 35 and 36; all of that portion of Sections 4, 8, 9 and 17, one mile distant from Great Basin Gas Transmission Company's (GBGTC) Mainline.
 10. Township 27 North, Range 32 East, M.D.B.& M. All of Sections 6, 7, 8, 16, 17, 18, 19, 20, 29, 30, 31 and 32; all of that portion of Sections 4, 5 and 9, one mile distant from GBGTC Eagle Picher No. 2 Lateral.
 11. All of Sections 35 and 36, Township 34 North, Range 34 East, M.D.B.& M.

<p>Issued: <div style="text-align: center;">April 28, 2023</div> Effective: <div style="text-align: center;">July 11, 2023</div> Advice Letter No.: <div style="text-align: center;">AL 534</div> </p>	<p>Issued by Amy L. Timperley Senior Vice President/ Chief Regulatory Officer</p>	
---	--	--

T
T

T

T
T
T

DESCRIPTION OF SERVICE AREA
(Continued)

B. The aforesaid service area of Southwest Gas Corporation is more particularly described as follows:

PARCEL 1: Beginning at the northwest (NW) corner of Section 6, Township 36 North, Range 37 East, M.D.B.& M., Humboldt County, Nevada; thence easterly along the north lines of Township 36 North, Range 37 and 38 East, to the northeast (NE) corner of Section 1, Township 36, Range 38 East; thence southerly along the east lines of Townships 36, 35 and 34 North, Range 38 East, crossing into Pershing County, to the southeast (SE) corner of Section 36, Township 34 North, Range 38 East; thence westerly along the south lines of Township 34 North, Ranges 38 and 37 East, to the southwest (SW) corner of Section 31, Township 34 North, Range 37 East; thence northerly along the west lines of Townships 34, 35 and 36 North, Range 37 East, crossing into Humboldt County, to the northwest (NW) corner of Section 6, Township 36 North, Range 37 East, the point of beginning.

PARCEL 2: Beginning at the southwest (SW) corner of Section 5, Township 26 North, Range 31 East, M.D.B.& M., Pershing County, Nevada; thence northerly along the west line of said Section 5 to the northwest (NW) corner of said Section 5; thence continuing northerly along the west line of Sections 32, 29, 20 and 17, Township 27 North, Range 31 East, M.D.B.& M. to a point in Section 17, said point being one mile distant from GBGTC Mainline; thence northeasterly one mile distant from said GBGTC Mainline through Sections 17, 8, 9 and 4, said township and range, to a point in Section 4, said point being one mile distant from GBGTC Mainline to the east line of said Section 4; thence southerly along the east line of Sections 4, 9 and 16 to the southeast (SE) corner of Section 16, said township and range; thence easterly along the north line of Sections 22 and 23 to the northeast (NE) corner of said Section 23, said township and range; thence northerly along the west line of Sections 13, 12 and 1 to a point in Section 1, said point being one mile distant from GBGTC Eagle Picher No. 2 Lateral; thence easterly one mile distant of said lateral in Section 1 to the east line of said Section 1, said township and range; thence continuing easterly one mile distant from GBGTC Eagle Picher No. 2 Lateral through Sections 6, 5 and 4, Township 27

<p>Issued: April 28, 2023</p> <p>Effective: July 11, 2023</p> <p>Advice Letter No.: AL 534</p>	<p style="text-align: center;">Issued by Amy L. Timperley Senior Vice President/ Chief Regulatory Officer</p>	
---	--	--

T
T
T
T
T

DESCRIPTION OF SERVICE AREA
(Continued)

B. PARCEL 2: (Continued)

North, Range 32 East, M.D.B. & M., to the east line of said Section 4, said township and range; thence southerly along the east line of Sections 4, 9 and 16, said township and range, to the southeast (SE) corner of said Section 16; thence westerly along the south line to the southwest (SW) corner of said Section 16; thence southerly along the east line of Sections 20, 29 and 32, to the southeast (SE) corner of Section 32, Township 27 North, Range 32 East, M.D.B. & M.; thence continuing southerly to the southeast (SE) corner of Section 5, Township 26 North, Range 32 East, M.D.B. & M.; thence westerly along the south line of Sections 5 and 6, said township and range, to the southwest (SW) corner of said Section 5; thence continuing westerly along the south line of Sections 1, 2, 3, 4 and 5, Township 26 North, Range 31 East, M.D.B. & M. to the southwest (SW) corner of Section 5, said corner being the point of beginning.

PARCEL 3: Beginning at the northwest (NW) corner of Section 35, Township 34 North, Range 34 East, M.D.B. & M., Pershing County, Nevada; thence easterly along the north lines of Sections 35 and 36, said township and range, to the northeast (NE) corner of said Section 36; thence southerly along the east line of Section 36, said township and range, to the southeast (SE) corner of said Section 36; thence westerly along the south lines of Sections 36 and 35, said township and range, to the southwest (SW) corner of said Section 35; thence northerly along the west line of Section 35, said township and range, to the point of beginning at the northwest (NW) corner of said Section 35.

<p>Issued: November 10, 2009</p> <p>Effective: November 1, 2009</p> <p>Advice Letter No.:</p>	<p>Issued by John P. Hester Senior Vice President</p>	
---	---	--

SOUTHWEST GAS CORPORATION
P.O. Box 98510
Las Vegas, Nevada 89193-8510
Nevada Gas Tariff No. 7

Canceling 1st Revised P.U.C.N. Sheet No. 117
Original P.U.C.N. Sheet No. 117

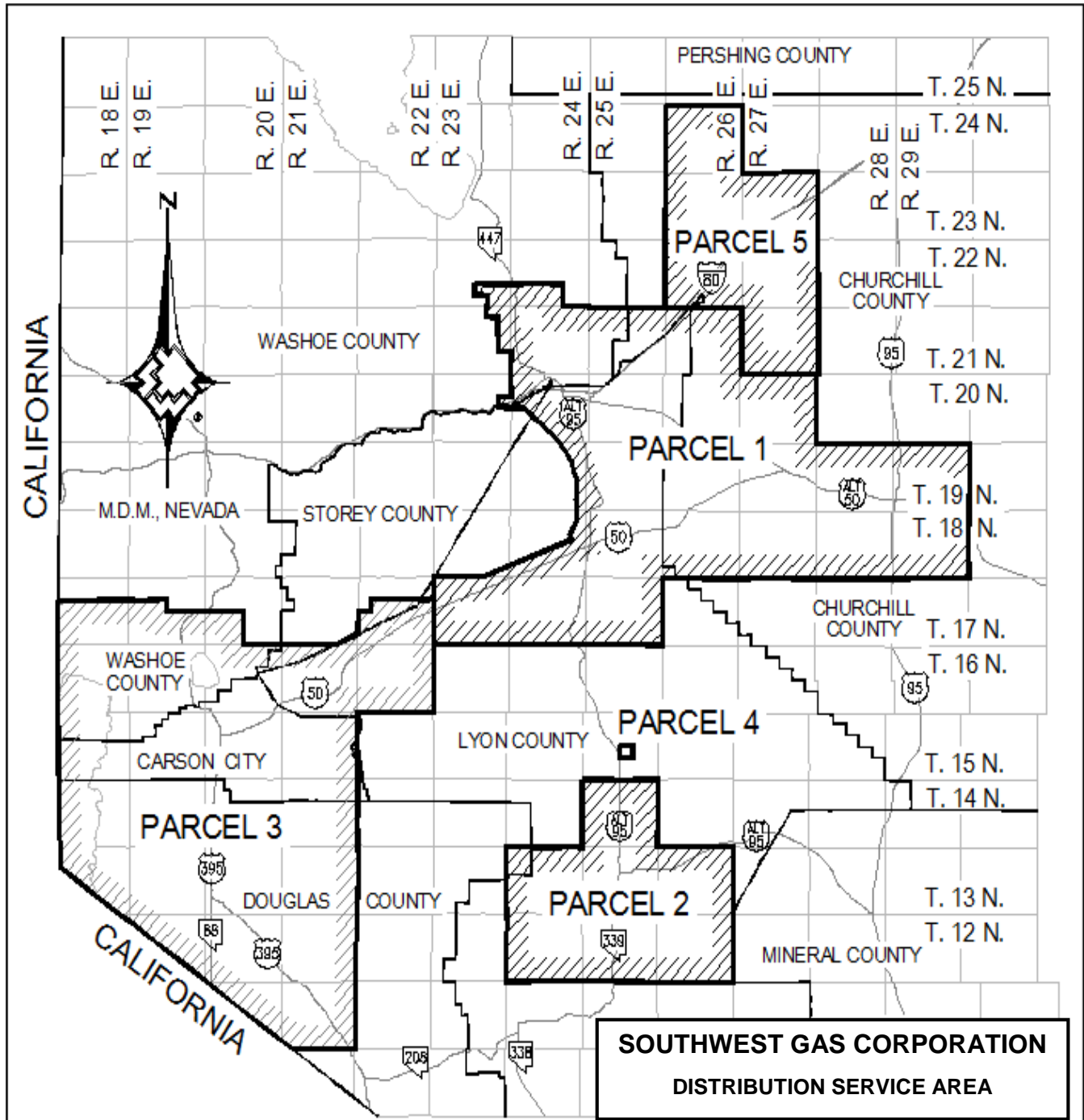

<p>Issued: September 11, 2015</p> <p>Effective: September 16, 2015</p> <p>Advice Letter No.:</p>	<p>Issued by Justin Lee Brown Vice President</p>	
--	--	--

DESCRIPTION OF SERVICE AREA

A. The service area of Southwest Gas Corporation in the Counties of Carson City, Douglas, Lyon, Washoe, Storey, and Churchill, State of Nevada, includes the following described area:

1. Township 24 North, Range 26 East, M.D.B.& M. All sections.
2. Township 23 North, Range 26 East, M.D.B.& M. All sections.
3. Township 23 North, Range 27 East, M.D.B.& M. All sections.
4. Township 22 North, Range 23 East, M.D.B.& M. All of Sections 25, 26, 27, 35, and 36.
5. Township 22 North, Range 24 East, M.D.B.& M. All of Sections 27, 28, 29, 30, 31, 32, 33, and 34.
6. Township 22 North, Range 26 East, M.D.B.& M. All sections.
7. Township 22 North, Range 27 East, M.D.B.& M. All sections.
8. Township 21 North, Range 23 East, M.D.B.& M. All of Sections 1, 2, 12, 13, and 24.
9. Township 21 North, Range 24 East, M.D.B.& M. All sections.
10. Township 21 North, Range 25 East, M.D.B.& M. All sections.
11. Township 21 North, Range 26 East, M.D.B.& M. All sections.
12. Township 21 North, Range 27 East, M.D.B.& M. All sections.
13. Township 20 North, Range 23 East, M.D.B.& M. All of Section 13.

N
N
N
L/T
L/T
N
N
L/T
L/T
L/T
N
L/T

<p>Issued: September 11, 2015</p> <p>Effective: September 16, 2015</p> <p>Advice Letter No.:</p>	<p>Issued by Justin Lee Brown Vice President</p>	
--	--	--

T
T

DESCRIPTION OF SERVICE AREA
(Continued)

- A. 14. Township 20 North, Range 24 East, M.D.B.& M. All of Sections 1, 2, 3, 4, 5, 6, 7, 8, 9, 10, 11, 12, 13, 14, 15, 16, 17, 22, 23, 24, 25, 26, 35 and 36. All that portion of Sections 18, 19, 20, 21, 27, 28 and 34 one-mile distant from the Great Basin Gas Transmission Company Lateral (Carson Lateral).
15. Township 20 North, Range 25 East, M.D.B.& M. All sections.
16. Township 20 North, Range 26 East, M.D.B.& M. All sections.
17. Township 20 North, Range 27 East, M.D.B.& M. All sections.
18. Township 19 North, Range 24 East, M.D.B.& M. All of Sections 1 and 12. All that portion of Sections 2, 3, 11, 13, 14, 24, 25 and 36 one-mile distant from the Great Basin Gas Transmission Company Lateral (Carson Lateral).
19. Township 19 North, Range 25 East, M.D.B.& M. All sections.
20. Township 19 North, Range 26 East, M.D.B.& M. All sections.
21. Township 19 North, Range 27 East, M.D.B.& M. All sections.
22. Township 19 North, Range 28 East, M.D.B.& M. All sections.
23. Township 19 North, Range 29 East, M.D.B.& M. All sections.
24. Township 18 North, Range 23 East, M.D.B.& M. All that portion of Sections 25, 34, 35 and 36 one-mile distant from the Great Basin Gas Transmission Company Lateral (Carson Lateral).
25. Township 18 North, Range 24 East, M.D.B.& M. All of Sections 13, 23, 24, 25, 26, 27, 28, 31, 32, 33, 34, 35 and 36. All that portion of Sections 1, 11, 12, 14, 15, 20, 21, 22, 29 and 30 one-mile distant from the Great Basin Gas Transmission Company Lateral (Carson Lateral).

<p>Issued: April 28, 2023</p> <p>Effective: July 11, 2023</p> <p>Advice Letter No.: AL 534</p>	<p>Issued by Amy L. Timperley Senior Vice President/ Chief Regulatory Officer</p>	
---	--	--

DESCRIPTION OF SERVICE AREA
(Continued)

- A. 26. Township 18 North, Range 25 East, M.D.B. & M. All sections.
- 27. Township 18 North, Range 26 East, M.D.B. & M. All sections.
- 28. Township 18 North, Range 27 East, M.D.B. & M. All sections.
- 29. Township 18 North, Range 28 East, M.D.B. & M. All sections.
- 30. Township 18 North, Range 29 East, M.D.B. & M. All sections.
- 31. Township 17 North, Range 18 East, M.D.B. & M. All of Sections 13, 14, 15, 16, 17, 18, 19, 20, 21, 22, 23, 24, 25, 26, 27, 28, 29, 30, 31, 32, 33, 34, 35, and 36.
- 32. Township 17 North, Range 19 East, M.D.B. & M. All of Sections 16, 17, 18, 19, 20, 21, 22, 23, 24, 25, 26, 27, 28, 29, 30, 31, 32, 33, 34, 35, and 36.
- 33. Township 17 North, Range 20 East, M.D.B. & M. All of Sections 19, 20, 21, 28, 29, 30, 31, 32, and 33.
- 34. Township 17 North, Range 21 East, M.D.B. & M. All that portion of Sections 35 and 36 in Lyon County.
- 35. Township 17 North, Range 22 East, M.D.B. & M. All of Sections 13, 14, 15, 16, 17, 19, 20, 21, 22, 23, 24, 25, 26, 27, 28, 29, 30, 31, 32, 33, 34, 35 and 36. All that portion of Section 12 one-mile distant from the Great Basin Gas Transmission Company Carson Lateral Line (Carson Lateral).
- 36. Township 17 North, Range 23 East, M.D.B. & M. All sections.
- 37. Township 17 North, Range 24 East, M.D.B. & M. All sections.
- 38. Township 17 North, Range 25 East, M.D.B. & M. All sections.

<p>Issued: April 28, 2023</p> <p>Effective: July 11, 2023</p> <p>Advice Letter No.: AL 534</p>	<p>Issued by Amy L. Timperley Senior Vice President/ Chief Regulatory Officer</p>	
---	--	--

T
T

T
T
T

DESCRIPTION OF SERVICE AREA
(Continued)

- A. 39. Township 16 North, Range 18 East, M.D.B. & M. All sections.
- 40. Township 16 North, Range 19 East, M.D.B. & M. All sections.
- 41. Township 16 North, Range 20 East, M.D.B. & M. All sections.
- 42. Township 16 North, Range 21 East, M.D.B. & M. All sections.
- 43. Township 16 North, Range 22 East, M.D.B. & M. All sections.
- 44. Township 15 North, Range 18 East, M.D.B. & M. All sections.
- 45. Township 15 North, Range 19 East, M.D.B. & M. All sections.
- 46. Township 15 North, Range 20 East, M.D.B. & M. All sections.
- 47. Township 15 North, Range 21 East, M.D.B. & M. All sections.
- 48. Township 14 North, Range 18 East, M.D.B. & M. All sections.
- 49. Township 14 North, Range 19 East, M.D.B. & M. All sections.
- 50. Township 14 North, Range 20 East, M.D.B. & M. All sections.
- 51. Township 14 North, Range 21 East, M.D.B. & M. All sections.
- 52. Township 14 North, Range 25 East, M.D.B. & M. All sections.
- 53. Township 13 North, Range 18 East, M.D.B. & M. All of Sections 1, 2, 3, 4, 5, 6, 7, 8, 9, 10, 11, 12, 13, 14, 15, 16, 22, 23, 24, and 25. All that portion of Sections 17, 18, 20, 21, 26, 27, 28, 35, and 36, northeasterly of the Nevada/California state line.

<p>Issued: September 11, 2015</p> <p>Effective: September 16, 2015</p> <p>Advice Letter No.:</p>	<p style="text-align: center;">Issued by Justin Lee Brown Vice President</p>	
--	--	--

L/T

L/T

T
T

DESCRIPTION OF SERVICE AREA
(Continued)

- A. 54. Township 13 North, Range 19 East, M.D.B.& M. All sections.
- 55. Township 13 North, Range 20 East, M.D.B.& M. All sections.
- 56. Township 13 North, Range 21 East, M.D.B.& M. All sections.
- 57. Township 13 North, Range 24 East, M.D.B.& M. All sections.
- 58. Township 13 North, Range 25 East, M.D.B.& M. All sections.
- 59. Township 13 North, Range 26 East, M.D.B.& M. All sections.
- 60. Township 12 North, Range 18 East, M.D.B.& M. All that portion of Section 1 northeasterly of the Nevada/California state line.
- 61. Township 12 North, Range 19 East, M.D.B.& M. All of Sections 1, 2, 3, 4, 5, 9, 10, 11, 12, 13, 14, 15, 23, 24, and 25. All that portion of Sections 6, 7, 8, 16, 17, 21, 22, 26, 27, 35, and 36, northeasterly of the Nevada/California state line.
- 62. Township 12 North, Range 20 East, M.D.B.& M. All of Sections 1, 2, 3, 4, 5, 6, 7, 8, 9, 10, 11, 12, 13, 14, 15, 16, 17, 18, 19, 20, 21, 22, 23, 24, 25, 26, 27, 28, 29, 30, 32, 33, 34, 35, and 36. All that portion of Section 31 northeasterly of the Nevada/California state line.
- 63. Township 12 North, Range 21 East, M.D.B.& M. All sections.
- 64. Township 12 North, Range 24 East, M.D.B.& M. All sections.
- 65. Township 12 North, Range 25 East, M.D.B.& M. All sections.
- 66. Township 12 North, Range 26 East, M.D.B.& M. All sections.

<p>Issued: September 11, 2015</p> <p>Effective: September 16, 2015</p> <p>Advice Letter No.:</p>	<p align="center">Issued by Justin Lee Brown Vice President</p>	
--	---	--

L/T

L/T

T
T

DESCRIPTION OF SERVICE AREA
(Continued)

A. 67. Township 11 North, Range 20 East, M.D.B.& M. All of Sections 1, 2, 3, 4, 10, 11, 12, 13, 14, and 24. All that portion of Sections 5, 6, 8, 9, 15, 16, 22, 23, 25, 26, and 36, northeasterly of the Nevada/California state line.

68. Township 11 North, Range 21 East, M.D.B.& M. All of Sections 1, 2, 3, 4, 5, 6, 7, 8, 9, 10, 11, 12, 13, 14, 15, 16, 17, 18, 19, 20, 21, 22, 23, 24, 25, 26, 27, 28, 29, 30, 32, 33, 34, 35, and 36. All that portion of Section 31 northeasterly of the Nevada/California state line.

69. All of Section 22, Township 15 North, Range 25 East, M.D.B.&M.

B. The aforesaid service area of Southwest Gas Corporation is more particularly described as follows:

PARCEL 1: Beginning at the northwest (NW) corner of Section 27, Township 22 North, Range 23 East, M.D.B.& M., Washoe County, Nevada; thence easterly along the north line of Section 27 to the northeast (NE) corner of Section 27, said Township and Range; thence southerly along the east boundary of said Section 27 of said Township and Range to a point in common with the northwest (NW) corner of Section 26, said Township and Range; thence easterly along the north lines of Sections 26 and 25, said Township and Range, continuing easterly along the north lines of Sections 30, 29, 28, and 27 to the northeast (NE) corner of Section 27, said Township, Range 24 East; thence southerly along the east lines of Sections 27 and 34 to the southeast (SE) corner of Section 34, said Township and Range; thence easterly along the north lines of Sections 2 and 1 to the northeast (NE) corner of Section 1, Township 21 North, Range 24 East; thence southerly along the east line of said Section 1 of said Township and Range to a point in common with the northwest (NW) corner of Section 6, said Township, Range 25 East; thence easterly along the north lines of Township 21 North, Ranges 25 and 26 East, crossing into Lyon and Churchill Counties, to the northeast (NE) corner of Section 1, Township 21 North, Range 26 East; thence southerly along the east lines of Sections 1, 12, 13, 24, 25, and 36 to the southeast (SE) corner of Section 36, Township 21 North,

<p>Issued: September 11, 2015</p> <p>Effective: September 16, 2015</p> <p>Advice Letter No.:</p>	<p style="text-align: center;">Issued by Justin Lee Brown Vice President</p>	
--	--	--

L/T
L/T
L
L
T
T

DESCRIPTION OF SERVICE AREA
(Continued)

B. PARCEL 1: (Continued)

Range 26 East; thence easterly along the north lines of Sections 6, 5, 4, 3, 2, and 1 to the northeast corner of Section 1, Township 20 North, Range 27 East; thence southerly along the east lines of Sections 1, 12, 13, 24, 25, and 36 to the southeast (SE) corner of Section 36, said Township and Range; thence easterly along the north lines of Township 19 North, Ranges 28 and 29 East to the northeast (NE) corner of Section 1, Township 19 North, Range 29 East; thence southerly along the east lines of Townships 19 and 18 North, Range 29 East to the southeast (SE) corner of Section 36, Township 18 North, Range 29 East; thence westerly along the south lines of Township 18 North, Ranges 29, 28, 27, and 26 East, crossing into Lyon County, to the southwest (SW) corner of Section 31, Township 18 North, Range 26 East; thence southerly along the east lines of Sections 1, 12, 13, 24, 25, and 36 to the southeast (SE) corner of Section 36, Township 17 North, Range 25 East; thence westerly along the south lines of Township 17 North, Ranges 25, 24, and 23 East to the southwest (SW) corner of Section 31, Township 17 North, Range 23 East; thence northerly along the west lines of Township 17 North, Range 23 East, to the northwest (NW) corner of Section 6, to a point on the Lyon/Storey County line; thence easterly along the south lines of Sections 31, 32, 33 and 34 Township 18 North, Range 23 East to a point, said point being one-mile distant from the Great Basin Gas Transmission Company Carson Lateral Line (Carson Lateral); thence continuing in a northeasterly direction along the one-mile distant from GBGTC's Carson Lateral through Sections 35, 36 and 25 to a point on the east line of Section 25, said Township and Range; thence continuing in a northeasterly and northerly direction along the one-mile distant from Carson Lateral through Sections 30, 29, 20, 21, 22, 15, 14, 11, 12 and 1 to a point on the north line of Section 1, Township 18 North, Range 24 East; thence continuing in a northerly and northwesterly direction along the one-mile distant from Carson Lateral through Sections 36, 25, 24, 13, 14, 11, 2 and 3 to a point on the north line of Section 3, Township 19 North, Range 24 East; thence continuing in a northwesterly direction along the one-mile distant from Carson Lateral through Sections 34, 27, 28, 21, 20, 19 and 18 to south line of said Section 18, Township 20 North, Range 24 East crossing into Storey and Washoe Counties; thence westerly along the south line of Section 18 a point on the west line

<p>Issued: April 28, 2023</p> <p>Effective: July 11, 2023</p> <p>Advice Letter No.: AL 534</p>	<p style="text-align: center;">Issued by Amy L. Timperley Senior Vice President/ Chief Regulatory Officer</p>	
---	--	--

T
T
T

T
T
T

DESCRIPTION OF SERVICE AREA
(Continued)

B. PARCEL 1: (Continued)

of Section 18, said Township and Range; thence westerly along the south line of Section 13, Township 20 North, Range 23 East to the southwest (SW) corner of said Section; thence northerly along the west line to the northwest (NW) corner of said Section; thence easterly along the north line to the northeast (NE) corner of said Section, Township and Range; thence northerly along the west lines of Sections 7 and 6, Township 20 North, Range 24 East to the northwest (NW) corner of said Section 6, Township and Range; thence northerly along the west lines of Sections 31 and 30 to the northwest (NW) corner of said Section 30, Township 21 North, Range 24 East; thence westerly along the south line of Section 24 to the southwest (SW) corner of Section 24, Township 21 North, Range 23 East; thence northerly along the west lines of Sections 24, 13, and 12 to the northwest (NW) corner of Section 12, said Township and Range; thence westerly along the south line of Section 2 to the southwest (SW) corner of Section 2, said Township and Range; thence northerly along the west line of Section 2 to the northwest (NW) corner of Section 2, said Township and Range; thence easterly along the north line of said Section 2 of said Township and Range to a point in common with the southwest (SW) corner of Section 35, Township 22 North, Range 23 East; thence northerly along the west line of Section 35 to the northwest (NW) corner of Section 35, said Township and Range; thence westerly along the south line of Section 27 to the southwest (SW) corner of Section 27, said Township and along the west line of Section 27 to the northwest (NW) corner of Section 27, Township 22 North, Range 23 East, the point of beginning.

B. PARCEL 2: Beginning at the northwest (NW) corner of Section 6, Township 14 North, Range 25 East, M.D.B. & M., Lyon County, Nevada; thence easterly along the north lines of Sections 6, 5, 4, 3, 2, and 1 to the northeast (NE) corner of Section 1, said Township and Range; thence southerly along the east lines of Sections 1, 12, 13, 24, 25, and 36 to the southeast (SE) corner of Section 36, said Township and Range; thence easterly along the north lines of Sections 6, 5, 4, 3, 2, and 1 to the

<p>Issued: September 11, 2015</p> <p>Effective: September 16, 2015</p> <p>Advice Letter No.:</p>	<p style="text-align: center;">Issued by Justin Lee Brown Vice President</p>	
--	--	--

L
L
T
T

DESCRIPTION OF SERVICE AREA

(Continued)

B. PARCEL 2: *(Continued)*

northeast (NE) corner of Section 1, Township 13 North, Range 26 East; thence southerly along the east lines of Townships 13 and 12 North, Range 26 East to the southeast (SE) corner of Section 36, Township 12 North, Range 26 East; thence westerly along the south lines of Township 12 North, Ranges 26, 25, and 24 East to the southwest (SW) corner of Section 31, Township 12 North, Range 24 East; thence northerly along the west lines of Townships 12 and 13, Range 24 East, crossing into Douglas County, to the northwest (NW) corner of Section 6, Township 13 North, Range 24 East; thence easterly along the north lines of Sections 6, 5, 4, 3, 2, and 1, crossing into Lyon County, to the northeast (NE) corner of Section 1, said Township and Range; thence northerly along the west lines of Sections 31, 30, 19, 18, 7, and 6 to the northwest (NW) corner of Section 6, Township 14 North, Range 25 East, the point of beginning.

B. PARCEL 3: Beginning at the point of intersection of the north line of Section 18, Township 17 North, Range 18 East, M.D.B.& M, with the California-Nevada state line, Washoe County, Nevada; thence easterly along the north lines of Sections 18, 17, 16, 15, 14, and 13, said Township and Range, continuing easterly along the north lines of Sections 18, 17, and 16 to the northeast (NE) corner of Section 16, said Township, Range 19 East; thence southerly along the east line of Section 16 to the southeast (SE) corner of Section 16, said Township and Range; thence easterly along the north lines of Sections 22, 23, and 24, said Township and Range, continuing easterly along the north lines of Sections 19, 20, and 21 to the northeast (NE) corner of Section 21, said Township, Range 20 East; (SE) corner of Section 33, said Township and Range; thence easterly along the north line of Sections 3, 2, and 1, crossing into Storey County, Township 16 North, Range 20 East, continuing easterly along the north lines of Sections 6, 5, 4, 3, and 2 to the Lyon County and Storey County Boundary Line in said Section 2, said Township, Range 21 East; thence northeasterly along said County Line through Sections 35 and 36 of Township 17 North, Range 21 East, to the east line of Section 36; thence northerly along the west lines of Sections 31, 30, and 19 to the northwest (NW) corner of

<p>Issued: September 11, 2015</p> <p>Effective: September 16, 2015</p> <p>Advice Letter No.:</p>	<p>Issued by Justin Lee Brown Vice President</p>	
--	--	--

L

L

T
T

DESCRIPTION OF SERVICE AREA
(Continued)

B. PARCEL 3: (Continued)

Section 19, Township 17 North, Range 22 East; thence easterly along the north line of Section 19 to the northeast (NE) corner of Section 19, said Township and Range; thence northerly along the west line of Section 17 to the northwest (NW) corner of Section 17, said Township and Range; thence easterly along the north lines of Sections 17, 16, 15, 14, and 13, crossing into Lyon County, to a point on the north line of Section 13 one-mile distant from the Carson Lateral; thence northeasterly along the one-mile distant from the Carson Lateral to the east line of Section 12, said Township and Range; thence southerly along the east lines of Sections 12, 13, 24, 25, and 36 to the southwest (SW) corner of Section 36, said Township and Range, continuing southerly along the east lines of Sections 1, 12, 13, 24, 25, and 36 to the southeast (SE) corner of Section 36, said Township and Range; thence westerly along the south lines of Sections 36, 35, 34, 33, 32, and 31 to the southwest (SW) corner of Section 31, said Township and Range; thence southerly along the east lines of Townships 15, 14, 13, 12, and 11 North, Range 21 East, crossing into Lyon, Carson City, and Douglas Counties, to the southeast (SE) corner of Section 36, Township 11 North, Range 21 East; thence westerly along the south lines of Sections 36, 35, 34, 33, 32, and 31 to the point of intersection of the south line of Section 31 with the California-Nevada state line, said Township and Range; thence northwesterly along said state line through Township 11 North, Ranges 21 and 20 East, Township 12 North, Ranges 20, 19, and 18 East, and Township 13 North, Range 18 East; thence northerly along said state line through Townships 13, 14, 15, and 16 North, Range 18 East, crossing Carson City and Washoe Counties, continuing northerly along said state line through Sections 31, 30, 19, and 18 to the northwest (NW) corner of Section 18, Township 17 North, Range 18 East, the point of beginning.

PARCEL 4: Beginning at the northwest (NW) corner of Section 22, Township 15 North, Range 25 East, M.D.B.&M., Lyon County, Nevada; thence easterly along the north line to the northeast (NE) corner of said Section 22, said Township and Range; thence southerly along the east line to the southeast (SE) corner of said Section 22,

<p>Issued: September 11, 2015</p> <p>Effective: September 16, 2016</p> <p>Advice Letter No.:</p>	<p align="center">Issued by Justin Lee Brown Vice President</p>	
--	---	--

DESCRIPTION OF SERVICE AREA
(Continued)

B. PARCEL 4: (Continued)

said Township and Range; thence westerly along the south line to the southwest (SW) corner of said Section 22, said Township and Range; thence northerly along the west line to the point of beginning at the northwest (NW) corner of said Section 22.

PARCEL 5: Beginning at the northwest (NW) corner of Township 24 North, Range 26 East, M.D.B.&M., Churchill County, Nevada; thence easterly along the north line thereof to the northeast (NE) corner of said Township and Range; thence southerly along the east line thereof to the northwest (NW) corner of Township 23 North, Range 27 East; thence easterly along the north line thereof to the northeast (NE) corner of said Township and Range; thence southerly along the east lines of Townships 23, 22 and 21 North, Range 27 East to the southeast (SE) corner of said Township 21 North, Range 27 East; thence westerly along the south line thereof to the southwest (SW) corner of said Township and Range; thence northerly along the westerly line thereof to the southeast (SE) corner of Township 22 North, Range 26 East; thence westerly along the south line thereof crossing through Lyon County, Nevada to the southwest (SW) corner of said Township and Range; thence northerly along the west lines of Townships 22, 23 and 24 North, Range 26 East to the point of beginning, being the northwest (NW) corner of said Township 24 North, Range 26 East.

<p>Issued: September 11, 2015</p> <p>Effective: September 16, 2015</p> <p>Advice Letter No.:</p>	<p>Issued by Justin Lee Brown Vice President</p>	
--	--	--

L
L
N
N

T
T

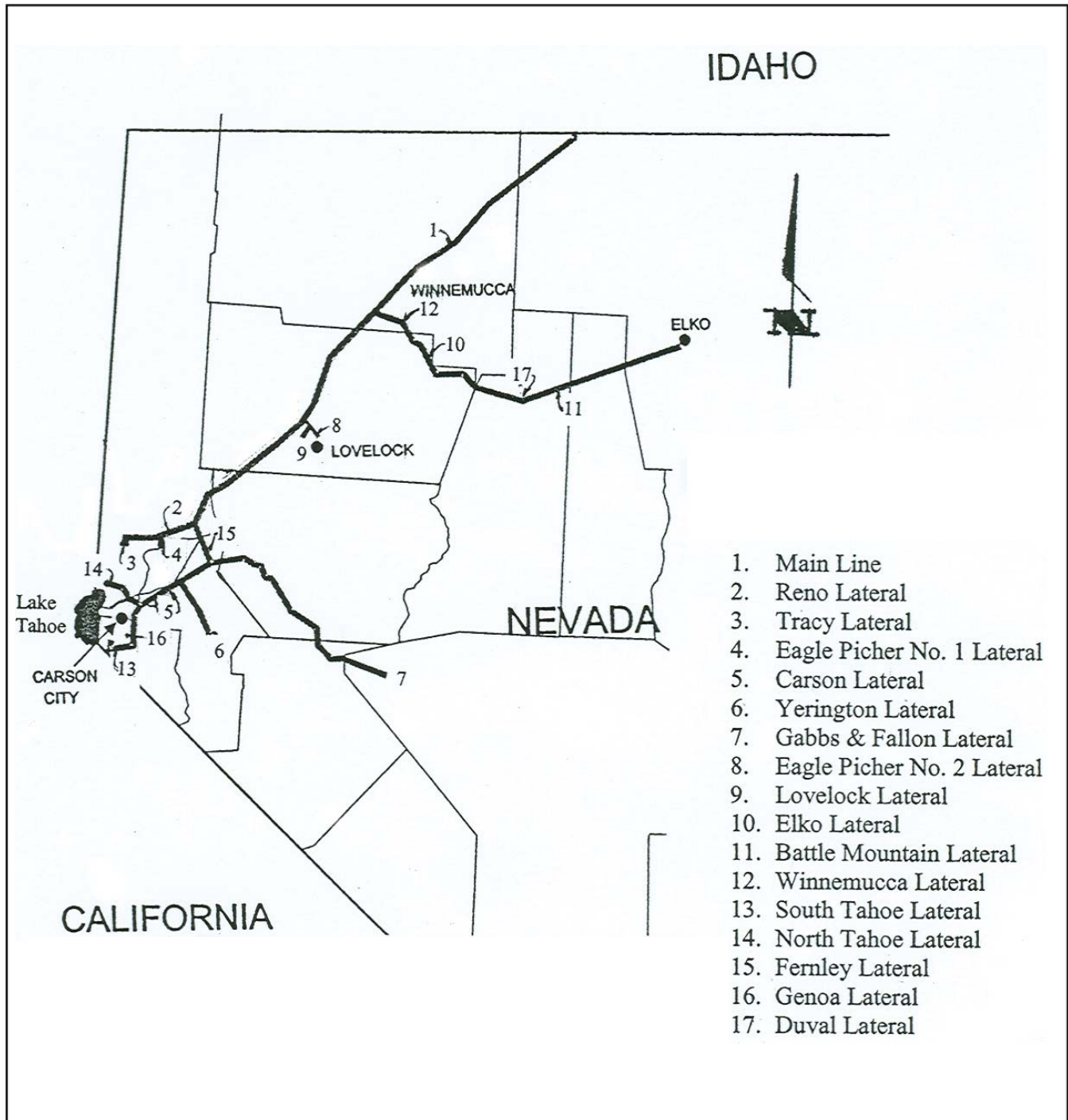

Issued:
November 10, 2009

Effective:
November 1, 2009

Advice Letter No.:

Issued by
John P. Hester
Senior Vice President

DESCRIPTION OF SERVICE AREA

- A. The service area of Southwest Gas Corporation in its Northern Nevada Division includes along its main transmission pipeline and lateral lines the following described areas:
1. MAIN LINE: A strip two (2) miles in width, one (1) mile on each side of the main transmission pipeline centerline, beginning at a point on the Idaho-Nevada state line in Section 5, Township 47 North, Range 48 East, M.D.B. & M., and continuing along the pipeline centerline in a southwesterly direction to the point of termination at the Golden Tee Intersection in Section 1, Township 20 North, Range 23 East, M.D.B. & M., Washoe County, Nevada.
 2. RENO LATERAL: A strip two (2) miles in width, one (1) mile on each side of the Reno Lateral pipeline centerline, beginning at the Golden Tee Intersection in Section 1, Township 20 North, Range 23 East, M.D.B. & M., and continuing along the pipeline centerline to the point of termination of said service area on the east line of Section 22, Township 20 North, Range 22 East, M.D.B. & M., Washoe County, Nevada; thence the Reno Lateral pipeline continues in a westerly direction to its point of termination in the northwest quarter (NW 1/4) of Section 36, Township 20 North, Range 19 East, M.D.B. & M., City of Reno, County of Washoe, Nevada.
 3. TRACY LATERAL: The Tracy Lateral pipeline centerline begins at a point on the Reno Lateral pipeline in Section 22, Township 20 North, Range 22 East, M.D.B. & M., Washoe County, Nevada, and continues along the pipeline centerline in a southerly direction to its point of termination in Section 33, Township 20 North, Range 22 East, M.D.B. & M., Storey County, Nevada.

<p>Issued: November 10, 2009</p> <p>Effective: November 1, 2009</p> <p>Advice Letter No.:</p>	<p>Issued by John P. Hester Senior Vice President</p>	
---	---	--

DESCRIPTION OF SERVICE AREA
(Continued)

- A. 4. EAGLE PICHER NO. 1 LATERAL: The Eagle Picher No. 1 pipeline centerline begins at a point on the Tracy Lateral pipeline in the southeast quarter (SE 1/4) of Section 28, Township 20 North, Range 22 East, M.D.B.& M., Washoe County, Nevada, and continues along the pipeline centerline in an easterly direction to a point on the east line of the southeast quarter (SE 1/4) of Section 27, Township 20 North, Range 22 East, M.D.B.& M., Washoe County, Nevada; thence the Eagle Picher No. 1 Lateral service area begins, being a strip two (2) miles wide, one (1) mile on each side of the pipeline centerline and continuing along the pipeline centerline in an easterly direction to its point of termination in the northwest quarter (NW 1/4) of the northeast quarter (NE 1/4) of Section 35, Township 20 North, Range 22 East, M.D.B.& M., Storey County, Nevada.
5. CARSON LATERAL: A strip two (2) miles in width, one (1) mile on each side of the Carson Lateral pipeline centerline, beginning at the Golden Tee Intersection in Section 1, Township 20 North, Range 23 East, M.D.B.& M., and continuing along the pipeline centerline in a southerly direction to its point of termination in Section 4, Township 14 North, Range 20 East, M.D.B.& M., Carson City, Nevada.
6. YERINGTON LATERAL: A strip two (2) miles in width, one (1) mile on each side of the Yerington Lateral centerline, beginning at a point on the Carson Lateral pipeline in Section 2, Township 17 North, Range 23 East, M.D.B.& M., and continuing along the pipeline centerline to the termination point in the town of Yerington, Nevada.
7. GABBS AND FALLON LATERAL: A strip two (2) miles in width, one (1) mile on each side of the Fallon Lateral centerline, beginning at a point on the Carson Lateral pipeline in Section 18, Township 19 North, Range 25 East, M.D.B.& M., and continuing along the pipeline centerline to a point south of Fallon, Nevada, which thence becomes the Gabbs Lateral pipeline continuing along the pipeline centerline to its termination point in Section 26, Township 12 North, Range 36 East, M.D.B.& M.

<p>Issued: November 10, 2009</p> <p>Effective: November 1, 2009</p> <p>Advice Letter No.:</p>	<p>Issued by John P. Hester Senior Vice President</p>	
---	---	--

DESCRIPTION OF SERVICE AREA

(Continued)

- A. 8. EAGLE PICHER NO. 2 LATERAL: A strip two (2) miles in width, one (1) mile on each side of the Eagle Picher No. 2 Lateral pipeline centerline, beginning at a point on the main transmission pipeline in Section 27, Township 28 North, Range 31 East, M.D.B.& M., continuing along the pipeline centerline to its termination point in Section 27, Township 28 North, Range 32 East, M.D.B.& M.
9. LOVELOCK LATERAL: A strip two (2) miles in width, one (1) mile on each side of the Lovelock Lateral centerline, beginning at a point on the Eagle Picher No. 2 Lateral pipeline in Section 27, Township 28 North, Range 31 East, M.D.B.& M., continuing along the pipeline centerline to its termination point in the city of Lovelock, Nevada.
10. ELKO LATERAL: A strip two (2) miles in width, one (1) mile on each side of the Elko Lateral pipeline centerline, beginning at a point on the main transmission pipeline in Section 24, Township 36 North, Range 36 East, M.D.B.& M., and continuing along the pipeline centerline to its termination point in the city of Elko, Nevada, and that portion more particularly described as follows:
- a. Township 35 North, Range 36 East, all of Section 1 and all of that portion of Sections 2 and 3 southeast of the Main Line Certificated Service Area right-of-way [right-of-way being one (1) mile on each side of pipeline].
 - b. Township 35 North, Range 37 East, all of that portion of Section 4 west of the Elko Lateral Certificated Service Area right-of-way [right-of-way being one (1) mile on each side of pipeline] and all of Sections 5 and 6.

Issued:
November 10, 2009

Effective:
November 1, 2009

Advice Letter No.:

Issued by
John P. Hester
Senior Vice President

DESCRIPTION OF SERVICE AREA
(Continued)

- A. 10. ELKO LATERAL: *(Continued)*
- c. Township 36 North, Range 36 East, all of that portion of Section 35 southeast of the Main Line Certificated Service Area right-of-way [right-of-way being one (1) mile on each side of pipeline] and all of that portion of Section 36 southeast of the Main Line and south of the Elko/Jungo Lateral Certificated Service Areas right-of-way [right-of-way being one (1) mile on each side of pipeline].
 - d. Township 36 North, Range 37 East, all of that portion of Section 31 south of the Elko/Jungo Lateral Certificated Service Area right-of-way [right-of-way being one (1) mile on each side of pipeline] and all of that portion of Section 32 south of the Elko/Jungo Lateral and west of the Elko Lateral Certificated Service Areas right-of-way [right-of-way being one (1) mile on each side of pipeline].
11. BATTLE MOUNTAIN LATERAL: A strip two (2) miles in width, one (1) mile on each side of the Battle Mountain Lateral centerline, beginning at a point on the Elko Lateral pipeline in Section 29, Township 31 North, Range 45 East, M.D.B. & M., and continuing along the pipeline centerline to its termination point in the town of Battle Mountain, Nevada.
12. WINNEMUCCA LATERAL: A strip two (2) miles in width, one (1) mile on each side of the Winnemucca Lateral pipeline centerline, beginning at a point on the main transmission pipeline in Section 24, Township 36 North, Range 36 East, M.D.B. & M., and continuing along the pipeline centerline to its point of termination in the city of Winnemucca, Nevada.
13. SOUTH TAHOE LATERAL: A strip two (2) miles in width, one (1) mile on each side of the South Tahoe Lateral pipeline centerline, beginning at the end of the Carson Lateral in Section 4, Township 14 North, Range 20 East, M.D.B. & M., and continuing along the pipeline centerline to the termination point in Section 27, Township 13 North, Range 18 East, M.D.B. & M.

<p>Issued: December 5, 2012</p> <p>Effective: January 1, 2013</p> <p>Advice Letter No.:</p>	<p>Issued by John P. Hester Senior Vice President</p>	
---	---	--

DESCRIPTION OF SERVICE AREA

(Continued)

- A. 14. NORTH TAHOE LATERAL: A strip two (2) miles in width, one (1) mile on each side of the North Tahoe Lateral centerline and beginning at a point on the Carson Lateral in Section 2, Township 15 North, Range 20 East, M.D.B.& M., and continuing along the pipeline centerline to the termination point in Section 23, Township 16 North, Range 18 East, M.D.B.& M.
15. FERNLEY LATERAL: A strip two (2) miles in width, one (1) mile on each side of the Fernley Lateral centerline and beginning at a point on the Carson Lateral in Section 22, Township 20 North, Range 24 East, M.D.B.& M., and continuing along the pipeline centerline to the termination point in the town of Fernley, Nevada.
16. GENOA LATERAL: A strip two (2) miles in width, one (1) mile on each side of the Genoa Lateral centerline and beginning at a point on the South Tahoe Lateral in Section 18, Township 13 North, Range 20 East, M.D.B.& M., and continuing along the pipeline centerline to the town of Genoa, Nevada.
17. DUVAL LATERAL: A strip two (2) miles in width, one (1) mile on each side of the Duval Lateral centerline, beginning at a point on the Elko Lateral pipeline in Section 4, Township 30 North, Range 43 East, M.D.B.& M., continuing along the pipeline centerline to its termination point in the Section 27, Township 31 North, Range 43 East, M.D.B.& M.

Issued:
November 10, 2009

Effective:
November 1, 2009

Advice Letter No.:

Issued by
John P. Hester
Senior Vice President

SOUTHWEST GAS CORPORATION
 P.O. Box 98510
 Las Vegas, Nevada 89193-8510
 Nevada Gas Tariff No. 7

Original _____ P.U.C.N. Sheet No. 134
 Canceling _____ P.U.C.N. Sheet No. _____

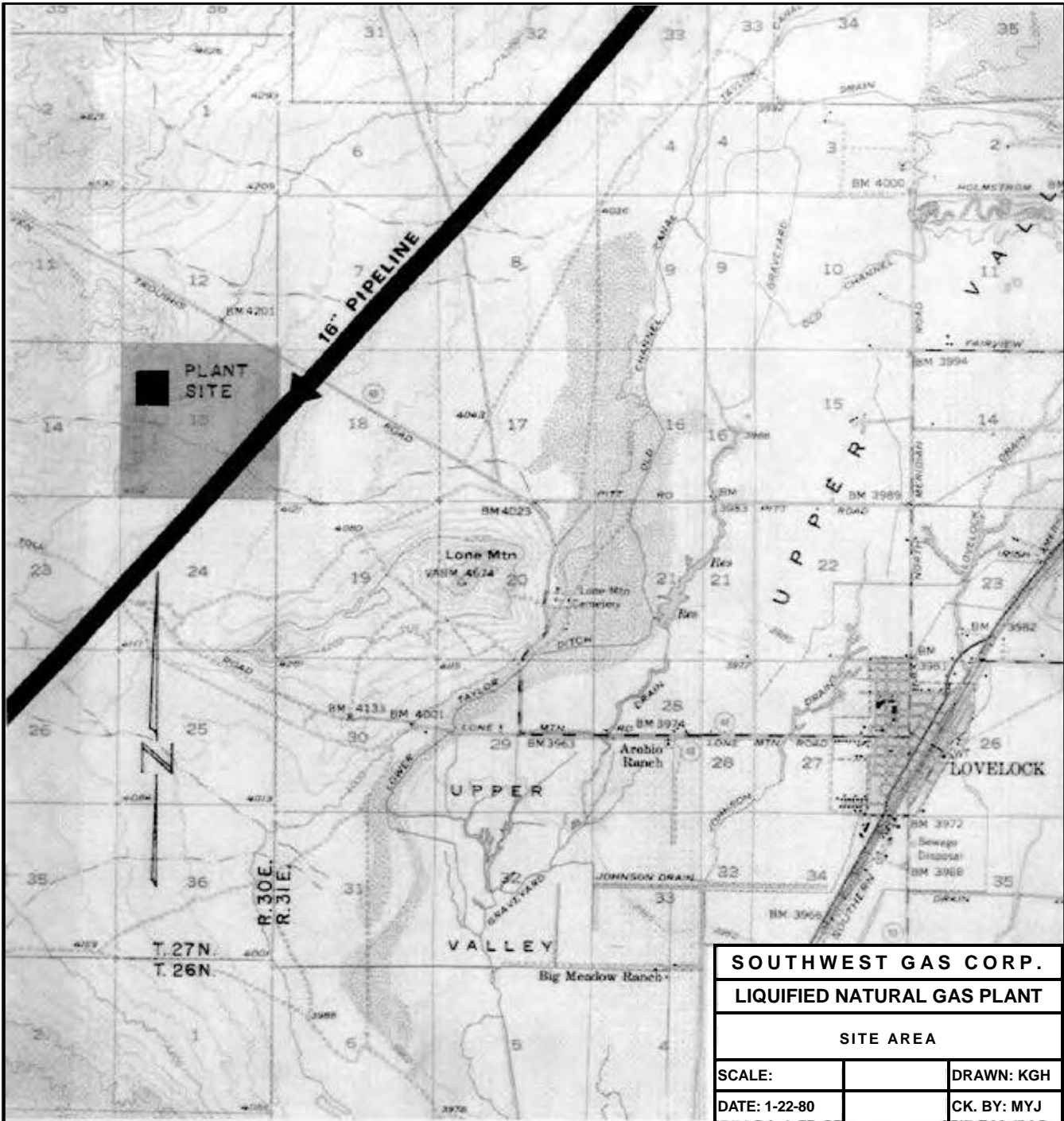

SOUTHWEST GAS CORP.		
LIQUIFIED NATURAL GAS PLANT		
SITE AREA		
SCALE:		DRAWN: KGH
DATE: 1-22-80		CK. BY: MYJ

Issued:
 November 10, 2009

Effective:
 November 1, 2009

Advice Letter No.:

Issued by
 John P. Hester
 Senior Vice President

DESCRIPTION OF PLANT SITE AREA

A. The site for the liquefied natural gas plant of Southwest Gas Corporation near Lovelock, County of Pershing, State of Nevada, is located in the northwest quarter (NW 1/4) of the following described area:

Section 13, Township 27 North, Range 30 East, M.D.B. & M.

B. The aforesaid area is more particularly described as follows:

Beginning at the northwest (NW) corner of Section 13, Township 27 North, Range 30 East, M.D.B. & M., Pershing County, Nevada; thence easterly along the north line of Section 13, to the northeast (NE) corner of said Section 13; thence southerly along the east line of Section 13 to the southeast (SE) corner of said Section 13; thence westerly along the south line of Section 13 to the southwest (SW) corner of said Section 13; thence northerly along the west line of Section 13 to the point of beginning at the northwest (NW) corner of Section 13.

<p>Issued: November 10, 2009</p> <p>Effective: November 1, 2009</p> <p>Advice Letter No.:</p>	<p>Issued by John P. Hester Senior Vice President</p>	
---	---	--

RULE NO. 1

DEFINITIONS

All Definitions are subject to interpretation by the Commission from time to time as the case for such interpretation may arise. For the purpose of these Tariff Schedules, the terms and expressions listed below shall have the meanings set forth opposite:

- Adult: A person 18 years of age or older.
- Agent: Any party a customer may contract with for purposes of administering the customer's service agreement with the Company. An Agent has only those rights designated in writing by such customer for the effective time period, excluding the right for the Agent to be directly billed by the Company.
- Annual Rate Adjustment (ARA): The annual rate filing that adjusts various portions of natural gas rates effective January 1.
- Applicant: A person or agency requesting the Company to supply natural gas service.
- Application: A request to the Company for natural gas service, as distinguished from an inquiry as to the availability or charges for such service.
- Average Month: 30.4 days.
- Basic Service Charge: An amount the customer must pay the Company for the availability of gas service, irrespective of whether any gas is used, as specified by the applicable rate schedule.
- Billing Period: The time interval between two consecutive meter readings that are taken for billing purposes.
- Branch Service: A service line that is not connected to a natural gas main and has as its source of supply another service line.
- British Thermal Unit: The amount of heat required to raise the temperature of one pound of water from 59°F to 60°F at constant pressure of 14.73 pounds per square inch absolute (psia).

<p>Issued: December 31, 2018</p> <p>Effective: January 1, 2019</p> <p>Advice Letter No.:</p>	<p>Issued by Justin Lee Brown Senior Vice President</p>	
--	---	--

RULE NO. 1

DEFINITIONS
(Continued)

Btu: British Thermal Unit.

Ccf: 100 cubic feet.

Cogeneration: The sequential production of electricity (or mechanical shaft power) and some useful form of thermal energy from a single input energy source.

Commercial Customer: A customer who is engaged primarily in the sale of goods or services including institutions and local, state and federal government agencies for uses other than those involving manufacturing or electric power generation.

Commission: Refers to the Public Utilities Commission of Nevada (PUCN).

Company: Southwest Gas Corporation.

Company's Operating Convenience: The term refers to the utilization, under certain circumstances of facilities or practices not ordinarily employed which contribute to the overall efficiency of the Company's operations; it does not refer to customer convenience nor to the use of facilities or adoption of practices required to comply with applicable laws, ordinances, rules or regulations, or similar requirements of public authorities.

Cubic Foot:

1. In cases where gas is supplied to customers at the standard delivery pressure, as specified in Rule No. 2, the volume of gas which, at the temperature and pressure existing in the meter, occupies one cubic foot.
2. In cases where gas is supplied to customers through positive displacement meters at other than standard delivery pressure, the volume of gas which, at 60°F and an absolute pressure of 14.73 pounds per square inch, occupies one cubic foot.

Curtailement Priority: As defined in the NAC and as set forth in Rule No. 8 of this Nevada Gas Tariff.

<p>Issued: December 31, 2018</p> <p>Effective: January 1, 2019</p> <p>Advice Letter No.:</p>	<p>Issued by Justin Lee Brown Senior Vice President</p>	
--	---	--

L
L

N
N
L

T

RULE NO. 1

DEFINITIONS
(Continued)

- Customer: The person or entity who receives or applies to receive service from the Company, as evidenced by the signature on the application or contract for that service, or, in the absence of a signed instrument, by the receipt and payment of bills regularly issued in the name of the service.
- Daily Nomination: A nomination submitted to the Company for one or more Gas Days. Daily Nominations must be submitted at least one calendar day prior to the effective Gas Day, subject to the provisions outlined in Schedule No. ST-1/NT-1.
- Date of Presentation: The date upon which a bill or notice is mailed (as postmarked) or delivered to the customer by the Company.
- Day: Calendar day.
- Delinquent Bill: A bill for service which is not paid prior to issuance of the next regular billing.
- Deposit: Security provided by a customer to ensure payment for service provided by the Company.
- Disabled: A person who (1) is affected by any physical or mental disability as described in NRS 615.110 or a substantial limitation to employment as defined in NRS 615.130; or (2) receives disability benefits from the Social Security Administration.
- Discontinuance of Service: Cessation of service by the Company at the request of the customer.
- Elderly: A person who is 62 years of age or older.

<p>Issued: April 1, 2022</p> <p>Effective: April 1, 2022</p> <p>Advice Letter No.:</p>	<p>Issued by Amy L. Timperley Vice President</p>	
--	--	--

D
T
T

RULE NO. 1

DEFINITIONS

(Continued)

Electric Generation Customer:	A customer who is engaged solely in the generation of electric power for resale to its customers.	L L
Electronic Billing:	A billing option customers may elect whereby the customer receives, views, and pays his/her gas bill electronically.	
Electronic Billing Service Provider:	The Company or its agent that provides electronic bill presentment and payment service for the Company and serves as a common link between the Company and the customer.	T T
Electronic Transfer:	Paperless exchange of data and/or funds.	
Especially Dangerous to Health:	A condition or event likely to cause serious impairment to the health of a person who appears to be unable, without assistance, to manage his/her own resources, carry out the activities of daily living or protect himself/herself from neglect or a hazardous situation.	
Excess Flow Valve:	A device designed to restrict the flow of gas in a customer's natural gas service line by automatically closing in the event of a service line break, thus mitigating the consequences of service line failures.	
FERC:	Federal Energy Regulatory Commission.	
Gas Day:	A period of 24 consecutive hours, except for those days that are adjusted for Daylight Savings Time, commencing and ending at 7:00 A.M. Pacific Clock Time (PCT). Clock Time indicates that the Company will adjust its Gas Day to reflect changes for Daylight Savings Time.	T
Guarantor:	A customer of the Company currently receiving service under this Nevada Gas Tariff who assumes liability for the payment of the bill of another customer in an amount not to exceed the appropriate amount of the deposit for the account of the customer.	

<p>Issued: December 31, 2018</p> <p>Effective: January 1, 2019</p> <p>Advice Letter No.:</p>	<p>Issued by Justin Lee Brown Senior Vice President</p>	
--	---	--

RULE NO. 1

DEFINITIONS
(Continued)

Industrial Customer: A customer who is engaged primarily in a process which creates or changes raw or unfinished materials into another form or product.

Inter-Divisional Capacity Transfer: A mechanism by which the unused off-peak interstate capacity of one of the Company's divisions is utilized by another of the Company's divisions to procure and transport otherwise inaccessible economically priced gas. The division owning the off-peak capacity receives benefit in the form of credits to its Deferred Energy Account. The division utilizing the off-peak capacity receives benefit through reduction in its purchased gas costs.

Interruptible Gas Service: Gas service subject to interruption or curtailment.

Intra-day Nomination: A Nomination submitted after the nominating deadline for Daily and Standing Nominations specified in Schedule No. ST-1/NT-1 which has an effective time no earlier than the beginning of the next Gas Day, and which has an ending time no later than the end of that Gas Day.

Law: A rule, or rules, established and enforced by federal, state, county or municipal authorities.

Main: A pipeline that serves as a common source of supply for more than one service line.

Main Extension: The length of main and its related facilities required to transport gas from the existing distribution facilities of the Company to the point of connecting with the service line.

Margin: The currently effective tariff sales rate, less the average cost of purchased gas and the surcharge(s) to amortize the balancing account(s), if any, included in the sales rate, multiplied by the units of gas used, plus the Basic Service Charge, demand charge and transportation service charge, calculated on an annual basis.

<p>Issued: April 1, 2022</p> <p>Effective: April 1, 2022</p> <p>Advice Letter No.:</p>	<p>Issued by Amy L. Timperley Vice President</p>	
--	--	--

N
N
T
T
T

RULE NO. 1

DEFINITIONS

(Continued)

Master Meter Customer: A customer who receives gas at a central point and distributes said gas through a piping system, not owned and operated by the Utility, to tenants or occupants for their individual consumption.

Master Meter System: A pipeline system for distributing gas within, but not limited to, a definable area, such as a mobile home park, housing project, or apartment complex, where the operator purchases metered gas from an outside source for resale through an exterior or underground pipeline to more than one building. The gas distribution pipeline system supplies the ultimate consumer who either purchases the gas directly through a meter or by other means, such as by rents.

Maximum Daily Quantity (MDQ): The maximum daily quantity of gas the Company agrees to receive or deliver, in a 24 hour period, at each receipt or delivery point or in the aggregate as specified in the service agreement.

Mcf: 1,000 cubic feet.

Meter: A measuring device and its related facilities downstream of the stop-cock, such as regulators, valves, pipe, fittings, supports, appliances, instruments, controls and telemetry.

Meter Snow Shelter A protective cover that protects the meter, stop-cock, and riser from damage caused by falling, sliding and accumulating snow and/or ice. The cover is designed to meet or exceed the building design snow load requirements as determined by the building development department, fire prevention department, or other authority having jurisdiction.

Mobile Home: A portable unit designed and built to be towed on its own chassis and connected to utilities. It is without a permanent foundation and is designed for year-round living.

<p>Issued: April 1, 2022</p> <p>Effective: April 1, 2022</p> <p>Advice Letter No.:</p>	<p>Issued by Amy L. Timperley Vice President</p>	
--	--	--

N
|
N
|
N
|
N
|
L
|
T
|
T

RULE NO. 1

DEFINITIONS

(Continued)

- Multi-Family Complex: A location at which more than one dwelling unit receives the benefits of a natural gas service through a single meter including, without limitation, apartment complexes and mobile home parks.
- Multi-Family Residential Structure: Any structure where three or more permanent residential dwellings joined by common walls each receive the benefits of natural gas service through an individual meter installed as part of a multiple-meter assembly.
- NAC: Nevada Administrative Code.
- Normal Working Hours: Except for Company-observed holidays, the period from 8 a.m. to 5 p.m., Monday through Friday.
- Ownership: The legal right of possession or proprietorship of the premise(s) where service is established.
- Pacific Clock Time (PCT): Pacific Standard Time or Pacific Daylight Time, whichever is currently in effect.
- Past Due Bill: A bill for service which is not paid within 15 days after issuance, or 19 days if payment is made by first-class mail.
- Permanent Service: Service which, in the opinion of the Company, is of an enduring and established character. The use of gas may be continuous, intermittent or seasonal in nature.
- Person: Any individual, partnership, corporation, governmental agency or other organization operating as a single entity.
- Pipeline Supplier: An interstate natural gas pipeline company subject to the Federal Energy Regulatory Commission's jurisdiction under the Natural Gas Act.
- Point of Delivery: The point where pipes owned, leased or under license by a customer contact the Company's pipes or outlet side at meter.

<p>Issued: April 1, 2022</p> <p>Effective: April 1, 2022</p> <p>Advice Letter No.:</p>	<p style="text-align: center;">Issued by Amy L. Timperley Vice President</p>	
--	--	--

L
L
L

L

T
T

RULE NO. 1

DEFINITIONS
(Continued)

Premises:	All real property and apparatus employed in a single-owner enterprise located on an integral parcel of land or on contiguous properties that are located immediately across a public right-of-way.
Primary Customer Owned Yard Line (COYL):	The primary customer gas piping that is owned and maintained by a customer that begins from the service point of delivery at the Company's meter at the property line or public right-of-way, and extends underground from the meter to a house, building, or gas utilization equipment where gas is consumed. A Primary COYL does not include secondary customer gas piping that may exist further downstream on a customer's houseline pipe facilities.
Priority:	Classification of gas use as determined in the NAC.
PUCN:	Public Utilities Commission of Nevada.
Residential Dwelling:	A house, apartment, townhouse or any other permanent residential unit that is used as a permanent home.
Rule:	A provision included herein which establishes the application of all rates, charges and standards for service when such applicability is not set forth in, and as a part of, a rate schedule.
Satisfactory Credit:	The payment of bills for utility service for 12 consecutive months, without a termination of service and with not more than three delinquent payments made during that period. Any history of payment that does not meet these requirements is unsatisfactory credit.
Service Area:	Territory in which the Company has the right to supply or make available gas service and is ready and willing to do so.
Service Line:	All pipes, valves and fittings from the main to and including the stop cock on the riser(s).

<p>Issued: <div style="text-align: center;">April 1, 2022</div> </p>	<p style="text-align: center;">Issued by Amy L. Timperley Vice President</p>	
<p>Effective: <div style="text-align: center;">April 1, 2022</div> </p>		
<p>Advice Letter No.:</p>		

RULE NO. 1

DEFINITIONS
(Continued)

- Service Line Extension: Service Line as above defined when constructed for a new customer at a premise not heretofore served in accordance with the service line extension rule.
- Service Line Shut-Off Valve: A curb valve or other manually operated valve located near the service that is safely accessible to Company personnel or other personnel authorized by the Company to manually shut off gas flow to the service line.
- Shrinkage: The cost of the gas quantities lost, unaccounted for, or used as company fuel in the transportation process and represented by the differential between the cost of gas on a sales basis and the cost of gas on a purchased basis.
- Shrinkage Rate: The rate used to recover the cost of shrinkage from non-exempt transportation customers. In Southern Nevada, the high pressure shrinkage rate will be calculated using the ratio of the high-pressure-system miles of pipe to the system total miles of pipe for both the high and low pressure systems, consistent with the calculation approved by the Commission in Docket No. 09-03012. High pressure includes all pipe systems that have a Maximum Allowable Operating Pressure (MAOP) of 125 psig or greater. Low pressure includes all pipe systems that have a MAOP of less than 125 psig. Customers receiving service off of a high pressure system will pay the high pressure shrinkage rate for all applicable therms. Customers receiving service off of a low pressure system will pay the low pressure shrinkage rate for all applicable therms.
- Single-Family Residential Structure: A permanent residential dwelling, excluding multi-family residential structures, that receives the benefits of natural gas service through an individual meter.
- Soft Credit Check: An inquiry initiated by the Company, with the applicant's consent, to a credit agency into a prospective customer's credit to determine creditworthiness. This type of inquiry will show up on a prospective customer's credit report but will not negatively impact that customer's credit score.

<p>Issued: April 1, 2022</p> <p>Effective: April 1, 2022</p> <p>Advice Letter No.:</p>	<p>Issued by Amy L. Timperley Vice President</p>	
--	--	--

L
L
L

T
T

RULE NO. 1

DEFINITIONS
(Continued)

- Soft Off: A meter read that occurs upon the discontinuance of service to a customer under this Nevada Gas Tariff where the supply of gas is not turned off, and there is no new customer at the premises.
- Standing Nomination: A Daily Nomination which is effective for multiple Gas Days. Standing Nominations cannot exceed the term of the customer's Transportation Service Agreement. A Standing Nomination can be replaced by a new Daily Nomination or Intra-day Nomination; however, upon the expiration of such replacement Nomination, the Standing Nomination becomes effective again.
- Subdivision: An area for single-family dwellings which may be identified by filed plans.
- Summer Season: The six month period beginning May 1 and ending October 31.
- Tariff: The entire body of effective rates, charges and rules, collectively, of the Company, as set forth herein.
- Temporary Service: Service to premises, enterprises or activities which are provisional or interim in nature, or where it is known in advance that the service will be of limited duration. Service which, in the opinion of the Company, is for operations of a speculative character, or the permanency of which has not been established, is also considered temporary service.
- Termination of Service: The intentional cessation of service by the Company to a customer which has not been requested by the customer and which occurs pursuant to the tariff of the Company.
- Therm: A unit of heating value equivalent to 100,000 British Thermal Units (Btu).
- Third-Party: Any person or public agency willing to receive monthly notifications in the event of a pending termination of service of a residential customer, who assumes no liability for the payment of the customer's bill.
- Timely Payment: The payment of a bill for service prior to the date the bill is past due, unless otherwise specified.

<p>Issued: October 19, 2021</p> <p>Effective: February 15, 2022</p> <p>Advice Letter No.: 527</p>	<p>Issued by Amy L. Timperley Vice President</p>	
--	--	--

T
T
T

L

T
T

RULE NO. 1

DEFINITIONS
(Continued)

Transportation Billing Quantity:	A customer's monthly scheduled transportation quantity or, if transportation service is provided at separate premises under a single service agreement, the sum of a customer's metered quantities, including the effect of any adjustment for cycle billing.
Utility:	Public Utility as defined in NRS 704.020 which furnishes gas; in this case Southwest Gas Corporation.
Weighted Average Cost of Gas:	(WACOG) The unit price of gas including the actual cost of the gas and delivery charges.
Winter Season:	The six month period beginning November 1 and ending April 30.

Issued: April 1, 2022	Issued by Amy L. Timperley Vice President	
Effective: April 1, 2022		
Advice Letter No.:		

RULE NO. 2

DESCRIPTION OF SERVICE

A. KIND AND HEATING VALUE

Gas supplied in the Company's service area consists of gas having a heating value of not less than 900 Btus per cubic foot at 60°F and an absolute pressure of 14.73 pounds per square inch (psia).

B. STANDARD DELIVERY PRESSURE

1. The standard delivery pressure maintained at the outlet of the customer's meter will be 0.25 pounds per square inch gauge (psig) subject to variation under load conditions.
2. In cases where a commercial or industrial customer desires service at greater than standard delivery pressure, the Company may supply such greater pressure if, and only as long as, the furnishing of gas to such customer at higher than standard delivery pressure will not be detrimental to the service to other customers of the Company. The Company reserves the right to lower said delivery pressure or discontinue the delivery of gas at higher pressure at any time upon reasonable notice to the customer.

C. DETERMINATION OF THERMS TO BE BILLED FOR APPLICABLE RATE SCHEDULES

1. Heating Value. The heating value (Btu per cubic foot) of the natural gas delivered will vary depending upon the source of supplies being received by the Company. The average heating values will be determined from the volumetric weighted average heating values of the supplies being received by the Company. Billing period heating values shall be the arithmetic average of the heating values as determined above for each day during such period.
2. Positive Displacement Metering. The number of therms to be billed will be determined by multiplying the difference in meter reading by an appropriate billing factor.

<p>Issued: November 10, 2009</p> <p>Effective: November 1, 2009</p> <p>Advice Letter No.:</p>	<p>Issued by John P. Hester Senior Vice President</p>	
---	---	--

RULE NO. 2

DESCRIPTION OF SERVICE
(Continued)

C. DETERMINATION OF THERMS TO BE BILLED FOR APPLICABLE RATE SCHEDULES
(Continued)

2. Positive Displacement Metering *(Continued)*

a. Accounts Supplied at Standard Delivery Pressure. The billing factor appropriate for accounts metered at standard delivery pressure will be developed from the average gas heating value, expressed in Btus per cubic foot, divided either by 100 for meter registrations in units of 100 cubic feet (Ccf) or by 1,000 for registrations in units of 1,000 cubic feet (Mcf), and the result will be multiplied by the proper combined altitude and delivery pressure adjustment value from the following tabulation:

<u>Altitude Zone No.</u>	<u>Elevation Range</u>	<u>Standard Barometric Pressure</u>	<u>Standard Delivery Pressure</u>	<u>Value</u>
1	0 – 199	14.73	14.98	1.0170
2	200 – 599	14.52	14.77	1.0027
3	600 – 999	14.32	14.57	.9891
4	1000 – 1399	14.11	14.36	.9749
5	1400 – 1799	13.91	14.16	.9613
6	1800 – 2199	13.72	13.97	.9484
7	2200 – 2599	13.52	13.77	.9348
8	2600 – 2999	13.33	13.58	.9219
9	3000 – 3399	13.14	13.39	.9090
10	3400 – 3799	12.95	13.20	.8961
11	3800 – 4199	12.77	13.02	.8839
12	4200 – 4599	12.58	12.83	.8710
13	4600 – 4999	12.41	12.66	.8595
14	5000 – 5399	12.23	12.48	.8473
15	5400 – 5799	12.05	12.30	.8350
16	5800 – 6199	11.88	12.13	.8235
17	6200 – 6599	11.71	11.96	.8119
18	6600 – 6999	11.54	11.79	.8004
19	7000 – 7399	11.38	11.63	.7895
20	7400 – 7799	11.21	11.46	.7780
21	7800 – 8199	11.06	11.31	.7677
22	8200 – 8599	10.90	11.15	.7570
23	8600 – 8999	10.74	10.99	.7464
24	9000 – 9399	10.59	10.84	.7360

Issued:
December 31, 2018

Effective:
January 1, 2019

Advice Letter No.:

Issued by
Justin Lee Brown
Senior Vice President

T

T

RULE NO. 2

DESCRIPTION OF SERVICE
(Continued)

C. DETERMINATION OF THERMS TO BE BILLED FOR APPLICABLE RATE SCHEDULES
(Continued)

2. Positive Displacement Metering (Continued)

- b. All Other Accounts. When a customer is served natural gas at higher than standard delivery pressure, the following correction or conversion factors, if applicable, will be applied to meter readings, in order to determine the therms for billing.

$$\frac{\text{Standard Barometric Pressure (psia)} + \text{Delivery Pressure (psig)}}{14.73 \text{ psia}} \times \frac{\text{Average Heating Value Btu/Cu.Ft.}}{100,000 \text{ Btu/Therm}} \times \frac{520}{460 + T} \times Y$$

Note: The volume of gas subject to commodity charges will be used on the difference between the current month's reading and the prior billing readings. For those meter readings in hundreds of cubic feet (Ccf) the difference in readings must be multiplied by 100 to obtain cubic feet (Cf) of usage for billing purposes. Standard delivery pressure is .25 psig.

- A = Correction for other than standard delivery pressure and altitude.
- B = Conversion to therms.
- C = Correction of temperature to 60° Fahrenheit (F).
- D = Correction for supercompressibility ratio.
- T = Temperature of gas in degrees Fahrenheit (F).
- Y = Correction for deviation from Boyle's Law.

<p>Issued: December 31, 2018</p> <p>Effective: January 1, 2019</p> <p>Advice Letter No.:</p>	<p>Issued by Justin Lee Brown Senior Vice President</p>	
--	---	--

RULE NO. 2

DESCRIPTION OF SERVICE
(Continued)

C. DETERMINATION OF THERMS TO BE BILLED FOR APPLICABLE RATE SCHEDULES
(Continued)

2. Positive Displacement Metering (Continued)

b. All Other Accounts (Continued)

In adjusting the metered gas volume to the standard pressure base of 14.73 psia, the standard barometric pressure assumed to exist at the meter for various altitudes shall be taken from the following table:

<u>Altitude Zone No.</u>	<u>Elevation Range</u>	<u>Standard Barometric Pressure</u>
1	0 – 199	14.73
2	200 – 599	14.52
3	600 – 999	14.32
4	1000 – 1399	14.11
5	1400 – 1799	13.91
6	1800 – 2199	13.72
7	2200 – 2599	13.52
8	2600 – 2999	13.33
9	3000 – 3399	13.14
10	3400 – 3799	12.95
11	3800 – 4199	12.77
12	4200 – 4599	12.58
13	4600 – 4999	12.41
14	5000 – 5399	12.23
15	5400 – 5799	12.05
16	5800 – 6199	11.88
17	6200 – 6599	11.71
18	6600 – 6999	11.54
19	7000 – 7399	11.38
20	7400 – 7799	11.21
21	7800 – 8199	11.06
22	8200 – 8599	10.90
23	8600 – 8999	10.74
24	9000 – 9399	10.59

<p>Issued: November 10, 2009</p> <p>Effective: November 1, 2009</p> <p>Advice Letter No.:</p>	<p>Issued by John P. Hester Senior Vice President</p>	
---	---	--

RULE NO. 2

DESCRIPTION OF SERVICE
(Continued)

D. AGREEMENTS NOT PROVIDED FOR IN THIS TARIFF

There are no understandings, agreements, representations, or warranties, express or implied (including warranties regarding merchantability or fitness for a particular purpose), not specified herein or in the applicable rules of the Commission concerning the sale and delivery of services by Company to the Customer. These terms and conditions and the applicable rules of the Commission state the entire obligation of the Company in connection with such sales and deliveries.

N
|
N

<p>Issued: December 31, 2018</p> <p>Effective: January 1, 2019</p> <p>Advice Letter No.:</p>	<p>Issued by Justin Lee Brown Senior Vice President</p>	
--	---	--

RULE NO. 3

APPLICATION FOR SERVICE

A. APPLICATION FOR SERVICE

The Company shall require each applicant for service to provide such information as stated in the content listing and also establish credit as provided for in Rule No. 12 of this Nevada Gas Tariff.

An applicant may apply for residential service from the Company by mail, by telephone, or on-line; however, if the applicant is applying for service for the first time, or has not received service from the Company during the preceding two years, such applicant may be required to apply for service in person.

1. Content. Such application may include the following information, but is not limited to:
 - a. Legal name of applicant(s).
 - b. Name of applicant's spouse or co-applicant.
 - c. Identification (Social Security number or driver's license number).
 - d. Date of birth.
 - e. Date and place of application.
 - f. Location of premises to be served.
 - g. Date applicant will be ready for service.
 - h. Previous address
 - i. Whether the premises have been previously supplied with gas.
 - j. Purposes for which service is to be used.
 - k. Address to which bills are to be mailed or delivered.
 - l. Rate schedule to be applied where optional rates are in effect.
 - m. Telephone number.
 - n. Third person identification, address and telephone number.
 - o. Whether customer or other permanent resident is elderly or disabled.
 - p. Such additional information as the Company may reasonably require.

<p>Issued: February 17, 2021</p> <p>Effective: May 1, 2021</p> <p>Advice Letter No.: 522</p>	<p>Issued by Justin Lee Brown Senior Vice President</p>	
--	---	--

N
L
L

RULE NO. 3

APPLICATION FOR SERVICE
(Continued)

A. APPLICATION FOR SERVICE (Continued)

2. Purpose. The application is a request for service and does not bind the applicant to take service for a period of time longer than that upon which the rates and minimum charge of the applicable rate schedule is based; neither does it bind the Company to serve except under reasonable conditions and in accordance with the applicable rules.

In the absence of a signed application or contract for service, the supplying of natural gas service by the Company and acceptance thereof by the customer shall be deemed to constitute a service agreement by and between the Company and the customer for delivery, acceptance of and payment for gas service and subject to the Company's applicable Rates and Rules and Regulations.

3. Third-Party Notification. At the time of application for service, the Company shall give written notice to each residential applicant who is elderly or disabled that a third-party may be designated by the applicant to receive notification of a pending termination of service.

If an applicant/co-applicant or customer lists a third-party whom they wish notified in the event that their service is scheduled for termination in accordance with Rule No. 6, such third-party's name, address and telephone number shall be noted on the application for service.

The Company shall make a diligent effort to notify the third-party of any pending termination, but the Company does not incur liability for failure to notify the third-party, nor is the third-party responsible for payment of the bill.

As used in this section, "third-party" includes any guarantor of the customer making the designation and any other person or public agency, other than the customer or the Company.

<p>Issued: December 31, 2018</p> <p>Effective: January 1, 2018</p> <p>Advice Letter No.:</p>	<p>Issued by Justin Lee Brown Senior Vice President</p>	
--	---	--

RULE NO. 3

APPLICATION FOR SERVICE
(Continued)

B. INDIVIDUAL LIABILITY FOR JOINT SERVICE

Two or more persons who join in one application for service shall be jointly and severally liable for proper use of the service and for payment of bills and shall be billed by means of single periodic bills to one person, as they may designate.

C. CHANGE IN CUSTOMER'S EQUIPMENT OR OPERATIONS

In the event that a customer shall make any substantial change either in the amount or character of the gas appliances or apparatus installed upon the customer's premises, the customer shall promptly notify the Company of such change.

D. CONNECTION OF SERVICE

The Company will endeavor to connect gas service as soon as possible after an application for service has been received.

E. SERVICE ESTABLISHMENT OR REESTABLISHMENT CHARGE

1. In order to partially cover the operating and clerical costs, the Company shall collect a service charge whenever service is established or reestablished as set forth and referred to as "Service Establishment Charge" in the currently effective Statement of Rates of this Nevada Gas Tariff. This charge will be applicable for establishing a new account or reestablishing service after having been ordered disconnected by the customer or terminated for nonpayment of bills or for failure otherwise to comply with filed rules or tariff schedules.

The service charge referenced above is not applicable to a customer whose service has been restored after having been disconnected as a result of its election to bypass the Company's distribution system and became its own gas supplier.

<p>Issued: November 10, 2009</p> <p>Effective: November 1, 2009</p> <p>Advice Letter No.:</p>	<p>Issued by John P. Hester Senior Vice President</p>	
---	---	--

RULE NO. 3

APPLICATION FOR SERVICE
(Continued)

E. SERVICE ESTABLISHMENT OR REESTABLISHMENT CHARGE (Continued)

2. When service is performed during a period when Company scheduling will next permit, a service charge for "normal service" will be applicable. As used herein, "normal service" is the service that is provided at a time that the Company can schedule such service during the normal course of its workday.
3. Where Company scheduling will not permit service required by the customer during normal working hours, the customer may elect to pay a service charge for "Expedited Service." There may be instances where Company scheduling will not permit "Expedited Service." However, in the event Company scheduling is available, in no case will "Expedited Service" take longer than 24 hours from the time requested.

F. COMPANY EASEMENTS AND RIGHTS OF INGRESS AND EGRESS

1. Upon the Company's request, the applicant shall provide, without cost to the Company, a non-exclusive perpetual easement in a form and upon terms that are satisfactory to the Company for the installation and maintenance of a gas pipeline or pipelines and appurtenances, across, over, under, and through the applicant's premises, together with the rights of ingress and egress and any temporary easements that are reasonably necessary for the Company to install, maintain, or replace the Company's gas facilities. If the applicant is not the property owner, then the applicant shall secure such easements from the property owner. The Company may request such easements whenever it determines that its existing easements or other property rights are unsatisfactory. Failure to provide such easements may be grounds for refusal of service.

<p>Issued: December 31, 2018</p> <p>Effective: January 1, 2019</p> <p>Advice Letter No.:</p>	<p>Issued by Justin Lee Brown Senior Vice President</p>	
--	---	--

T
N
N
N

T

RULE NO. 3

APPLICATION FOR SERVICE
(Continued)

F. COMPANY EASEMENTS AND RIGHTS OF INGRESS AND EGRESS (Continued)

2. An easement or other property rights may be unsatisfactory if, among other things, it burdens the Company with undue costs (including costs related to indemnification, insurance, or the maintenance and restoration of the burdened estate); fails to provide a safe, convenient, and economical means for the placement, operation, or access to the Company's gas facilities; seeks to confer benefits for the applicant or a customer that are unjust, unreasonable, unjustly discriminatory, or preferential; is vague or ambiguous; or conflicts with this Tariff or with the Commission rules and regulations.

<p>Issued: December 31, 2018</p> <p>Effective: January 1, 2019</p> <p>Advice Letter No.:</p>	<p>Issued by Justin Lee Brown Senior Vice President</p>	
--	---	--

RULE NO. 4

NOTICES

A. COMPANY NOTICE TO CUSTOMERS

1. In Writing. Notice to a customer will normally be in writing and provided through the U.S. mail or delivered by the Company to the customer's last known address.
2. Electronic. Customers electing Electronic Billing will receive notices through their electronic bill or via U.S. mail.
3. Exception. In emergencies or when circumstances warrant, the Company, where feasible, will endeavor to promptly notify the customer affected and may make such notification verbally, either in person or by telephone.

B. CUSTOMER NOTICE TO COMPANY

The Company shall not be responsible for notices given to it by the customer, unless they are given in writing. Such notice shall be delivered at an office of the Company in person or by U.S. mail.

<p>Issued: December 31, 2018</p> <p>Effective: January 1, 2019</p> <p>Advice Letter No.:</p>	<p>Issued by Justin Lee Brown Senior Vice President</p>	
--	---	--

T

T

RULE NO. 5

BILLS FOR SERVICE

A. RENDERING OF BILLS

1. Bills for service will be rendered to each customer not less frequently than once each month and, except as otherwise provided in Section A.1.b. herein, will be based upon:

a. Meter Registration

- (1) Bills based on therm usage for gas service will show the reading of the meter at the start of the billing period, the reading of the meter at the end of the period for which the bill is rendered, the date of such reading, the billing factor and the number of therms of gas used.
- (2) Bills based on other than therms for gas service will show the reading of the meter at the start of the billing period, the reading of the meter at the end of the period for which the bill is rendered, the date of such reading and the volume of gas used.
- (3) Each meter on a customer's premises will be considered separately and the readings of two or more meters will not be combined, except where the Company's operating convenience or necessity may require the use of more than one meter.

b. Estimated Consumption

- (1) If, for reasons beyond its control, the Company is unable to read the customer's meter on the scheduled reading date, the Company shall bill the customer for estimated consumption during the billing period, subject to adjustment at the time the meter is next read. Such bill shall reflect that it is based upon estimated usage.

<p>Issued: December 31, 2018</p> <p>Effective: January 1, 2019</p> <p>Advice Letter No.:</p>	<p>Issued by Justin Lee Brown Senior Vice President</p>	
--	---	--

T
T

T

RULE NO. 5

BILLS FOR SERVICE
(Continued)

A. RENDERING OF BILLS (Continued)

b. Estimated Consumption (Continued)

- (2) Gas bills cannot be estimated unless one of the following conditions exists:
- (a) Severe weather;
 - (b) The presence of an animal on the premises of the customer which prevents an employee of the Company from reading the meter without risk of injury; or
 - (c) Some unusual circumstance which makes it unreasonably difficult to read the meter and/or process a reading.
- (3) When the Company issues three consecutive bills to a customer based upon estimated usage, or five such bills for a customer in the area surrounding Lake Tahoe, the customer shall be notified of the Company's right of access, as provided in Rule No. 16, to the premises of the customer. Thereafter, any additional and consecutive bill based upon estimated usage may be issued only under extraordinary circumstances. In the event the customer is unwilling to provide the Company with access to the meter, the Company shall, at the customer's option, either relocate the meter at the customer's expense or discontinue the customer's service.

Issued:
December 31, 2018

Effective:
January 1, 2019

Advice Letter No.:

Issued by
Justin Lee Brown
Senior Vice President

T
T

T

RULE NO. 5

BILLS FOR SERVICE
(Continued)

A. RENDERING OF BILLS (Continued)

b. Estimated Consumption (Continued)

- (4) If an estimated bill is warranted, it can only be done by taking into account any of the following factors when applicable:
- (a) The customer's gas usage during the same month of the preceding year;
 - (b) Any change in temperature from the preceding month;
 - (c) The amount of gas consumed during the preceding month; or
 - (d) Seasonal load factors.

2. Each bill for residential service will contain the following minimum information:

- a. Any previous balance;
- b. The amount due for service provided during the current billing period, with the date upon which this amount is past due;
- c. Any approved charge for late payment of a bill, with the date upon which that charge begins to accrue;
- d. The customer charge;
- e. The fuel adjustment cost and gas adjustment cost
- f. Any other authorized fee, charge or tax;
- g. Any unregulated charge;
- h. The total of the preceding amounts;

<p>Issued: November 10, 2009</p> <p>Effective: November 1, 2009</p> <p>Advice Letter No.:</p>	<p>Issued by John P. Hester Senior Vice President</p>	
---	---	--

RULE NO. 5

BILLS FOR SERVICE
(Continued)

A. RENDERING OF BILLS (Continued)

2. (Continued)

- i. A formula which the customer may use for calculating the amount of the customer's bill;
- j. The meter readings for the first and last day of the billing period;
- k. The quantity of gas consumed;
- l. The date the meter was read;
- m. The next date the meter will be read;
- n. A summary of the provisions for a customer to dispute a bill for service; and
- o. The telephone number and address of the office of the Company where a customer may obtain information concerning the customer's bill or the service provided.

B. ELECTRONIC BILLING

Electronic Billing is an optional billing service whereby customers may elect to receive, view and pay their gas bills electronically. An electronic bill may be generated in lieu of a paper bill under the following conditions:

- 1. Customers requesting this service may be required to complete additional forms and agreements with the Company and/or the Electronic Billing Service Provider.

<p>Issued: December 31, 2018</p> <p>Effective: January 1, 2019</p> <p>Advice Letter No.:</p>	<p>Issued by Justin Lee Brown Senior Vice President</p>	
--	---	--

RULE NO. 5

BILLS FOR SERVICE
(Continued)

B. ELECTRONIC BILLING *(Continued)*

2. Electronic Billing may be discontinued at any time by the Company, the customer or the Electronic Billing Service Provider.
3. Except as otherwise provided in this section, all other provisions of the Company's Rules and Regulations as contained in this Nevada Gas Tariff are applicable to Electronic Billing and made a part hereof.

C. SUMMARY BILLING

Summary Billing is an optional billing service for sales customers whereby customers with several individual accounts may receive a summary bill with summarized billing data for these accounts. A summary bill may be generated in lieu of the individual bills under the following conditions:

1. Customers electing this service shall execute a service agreement in order to participate in Summary Billing.
2. Eligibility for this service is limited to customers with a minimum of ten individual accounts.
3. The customer name on all of the individual accounts summarized under any one Summary Billing account must be the same.
4. Each month's payment of a summary bill for the "Amount Due" must be one payment in the form of a check, cashier's check or money order drawn on a bank or other financial institution and payable to the Company in U.S. currency, unless other arrangements acceptable to the Company have been previously established.
5. Payment of a summary bill is past due and subject to a late charge if the payment is not received within 15 days after its issuance.

<p>Issued: December 31, 2018</p> <p>Effective: January 1, 2019</p> <p>Advice Letter No.:</p>	<p>Issued by Justin Lee Brown Senior Vice President</p>	
--	---	--

RULE NO. 5

BILLS FOR SERVICE
(Continued)

C. SUMMARY BILLING (Continued)

6. The Company shall not be required to offer or to continue to offer Summary Billing to any customer whose account(s) is(are) past due or in arrears.
7. Except as otherwise provided in this section, all other provisions of the Company's Rules and Regulations as contained in this Nevada Gas Tariff are applicable to Summary Billing and are made a part hereof.

D. PRORATION OF BILLS

With the exception of opening bills for periods of less than 27 days, no proration shall be made to the Basic Service Charge and no bill shall be less than the specified minimum charge.

E. PAYMENT OF BILLS

1. Bills for service are due and payable upon the date of presentation. Payment may be made by:
 - a. Depositing current bill payment with the U.S. Postal Service for delivery to the Company by first class mail.
 - b. Making payment at the business office of the Company.
 - c. Making payment to any representative authorized by the Company to accept payment.
 - d. Payments are required to be made in cash, by check, money order, certified check, electronic transfer, credit card acceptable to the Company, or any other means mutually agreeable to the Company and the customer. A fee may be assessed by a third-party vendor or financial institution for utilization of third-party bill payment vendor or debit/credit card company services.

<p>Issued: December 31, 2018</p> <p>Effective: January 1, 2019</p> <p>Advice Letter No.:</p>	<p>Issued by Justin Lee Brown Senior Vice President</p>	
--	---	--

T
T

T

RULE NO. 5

BILLS FOR SERVICE
(Continued)

E. PAYMENT OF BILLS *(Continued)*

2. The date a bill is past due may not be earlier than 15 days after its issuance. If the last day for payment before a bill becomes past due falls on a Sunday, legal holiday or any other day when the office of the Company used for the payment of bills is closed, the last day for payment will be the next business day. Except as otherwise provided in Section E.3 herein, payment of a bill by first class mail is timely if the payment is received not more than four days after the past due date.
3. Any arrearage contained in a bill for service is delinquent and should be paid at the business office of the Company.

F. LATE CHARGE

The Company shall be allowed to recover a charge as set forth in each rate schedule of this Nevada Gas Tariff for the late payment of a bill.

G. RETURNED ITEM CHARGE

Should an item from a customer used to pay a bill for service be returned to the Company as uncollectible for any reason, including a lack of sufficient funds, the Company shall be allowed to recover a charge as set forth in the currently effective Statement of Rates, Other Service Charges, of this Nevada Gas Tariff. The Company will require the customer to make full payment in cash or by money order or cashier's check. The customer whose item is returned to the Company as uncollectible shall in no way be relieved of the obligation to render payment to the Company under the original terms of the bill or defer the Company's provision for termination of service for nonpayment of bills.

<p>Issued: December 31, 2018</p> <p>Effective: January 1, 2019</p> <p>Advice Letter No.:</p>	<p>Issued by Justin Lee Brown Senior Vice President</p>	
--	---	--

RULE NO. 5

BILLS FOR SERVICE
(Continued)

H. EQUAL PAYMENT PLAN

1. The Equal Payment Plan (EPP) is available to all residential customers receiving (or applicants qualifying and applying to receive) natural gas service.
2. If a customer requests to participate in the EPP and the customer has an arrearage when the request is made, the customer may not enter the EPP unless the customer:
 - a. Pays at least 50% of the arrearage upon entering the EPP; and
 - b. Agrees to pay the remaining arrearage in amounts that are apportioned over the first year of participation.
3. Participation in the EPP is subject to approval by the Company. Customers may sign up for the EPP at any time of year. The EPP amount will be based on the annual estimated bill divided into 12 equal monthly payments.
4. The Company will render its regular monthly billing statement showing both the amount for actual usage for the period and the designated EPP amount. The customer will pay the designated EPP amount, plus any additional amount shown on the bill for materials, parts, labor or other charges.
5. The settlement month will be the customer's anniversary date, 12 months from the time the customer entered the EPP. The settlement amount is the difference between the EPP payments made and the amount actually owing based on actual usage during the period the customer was billed under the EPP. All debit amounts are due and payable in the settlement month. However, debit amounts of \$50 or less may be carried forward and added to the total annual estimated bill for the next EPP year. Credit amounts of \$50 or less will be carried forward and applied against the first billing or billings due in the next EPP year. Credit amounts over \$50 will be refunded by check.

<p>Issued: December 31, 2018</p> <p>Effective: January 1, 2019</p> <p>Advice Letter No.:</p>	<p>Issued by Justin Lee Brown Senior Vice President</p>	
--	---	--

RULE NO. 5

BILLS FOR SERVICE
(Continued)

H. EQUAL PAYMENT PLAN (Continued)

6. The EPP amount may be adjusted quarterly to reduce the likelihood of an excessive debit or credit balance in the settlement month, for changes in rates due to Commission-approved rate increases or decreases greater than five percent, or when estimates indicate that an overpayment or undercollection of \$50 or more may occur by the end of the plan year.
7. The Company may remove from the EPP and place on regular billing any customer who fails to make two or more consecutive timely payments according to that customer's EPP obligation. Such a customer will then be subject to termination of service in accordance with Rule No. 6 for nonpayment of a bill.
8. Readmission to the EPP will be subject to approval by the Company and payment in full of all past due amounts.
9. A customer may voluntarily withdraw from the EPP at any time. Any amounts then owing for usage in excess of usage already paid for under the EPP will become due and payable at the customer's next regular billing, in accordance with the Company's filed tariff schedules. Any EPP payments in excess of amounts based upon actual usage at the time of withdrawal will be applied to the customer's next regular monthly bill or will be refunded by check if so requested by the customer.

<p>Issued: December 31, 2018</p> <p>Effective: January 1, 2019</p> <p>Advice Letter No.:</p>	<p>Issued by Justin Lee Brown Senior Vice President</p>	
--	---	--

RULE NO. 6

DISCONTINUANCE, TERMINATION, RESTORATION AND REFUSAL OF SERVICE

A. CUSTOMER'S REQUEST FOR DISCONTINUANCE OF SERVICE

1. Unless otherwise covered by service agreement between customer and Company, a customer may have service discontinued by giving not less than five business days' advance notice thereof to the Company. Charges for service may be required to be paid until the requested date of discontinuance or such later date as will provide not less than the required five business days' advance notice.
2. When such advance notice is not given to the Company, the customer may be required to pay for service until five business days after the Company has knowledge that the customer has vacated the premises or otherwise discontinued service.
3. To discontinue service, the Company will either read the meter for a new customer, turn off the supply of gas, or perform a soft off. Soft offs will only be performed on residential services located on the exterior of the customer's residence. The Company will turn off the supply of gas no more than 30 calendar days after the soft off. If the soft off or turn off date falls on a Saturday, Sunday, or state or federal holiday, the date may be continued to the next business day, and in all events, the Company may extend the dates on account of weather conditions.

<p>Issued: October 19, 2021</p> <p>Effective: February 15, 2022</p> <p>Advice Letter No.: 527</p>	<p>Issued by Amy L. Timperley Vice President</p>	
---	--	--

N
|
N
|
L

T
T

RULE NO. 6

B. TERMINATION OF SERVICE BY COMPANY WITH NOTICE

1. For Nonpayment of Bills

- a. A customer's service may be terminated for nonpayment of a delinquent bill, provided the Company has given the customer advance notice of such intention in accordance with Section C hereof.
- b. A customer's service may be terminated for nonpayment of a delinquent bill for service furnished at a previous location if the delinquent bill is not paid after presentation at the new location and notice of intention to terminate service is given in accordance with Section C herein.
- c. If a customer is receiving residential service at more than one location, service at any of the locations may be terminated if bills for service at any location is not paid prior to the time of the next regular billing, provided the Company has given the customer prior notice in accordance with Section C, Notice Requirements for Termination of Service herein.

Issued:
October 19, 2021

Effective:
February 15, 2022

Advice Letter No.:
527

Issued by
Amy L. Timperley
Vice President

RULE NO. 6

DISCONTINUANCE, TERMINATION, RESTORATION AND REFUSAL OF SERVICE
(Continued)

B. TERMINATION OF SERVICE BY COMPANY WITH NOTICE (Continued)

1. For Nonpayment of Bills (Continued)

d. If the Company intends to terminate service at a location having a master meter, it must use best efforts to post notice of its intended action in a conspicuous place at the location. If the service to be terminated is at a mobile home park having a master meter or a multi-family complex, the Company must also use best efforts to provide notice to the occupants of each mobile home and each family dwelling unit. Notice to the occupants shall be effected by a written posting on the door stating (1) the arrearage amount, (2) the deadline for making payment to avoid termination of service and (3) the date of termination of service, in the event payment is not made. Advance notice of the Company's intent to terminate service shall be given in accordance with Section C herein.

2. For Noncompliance with Rules

In any case of violation of these rules not specifically covered herein, the Company may terminate service to any customer after it has given the customer notice of such intention in accordance with Section C herein.

C. NOTICE REQUIREMENTS FOR TERMINATION OF SERVICE

1. If the Company has grounds to terminate service pursuant to Section B herein, an initial 10 day notice shall be presented, either personally, by first class mail, or if requested by the customer, electronically via the Internet to the most recent electronic address provided to the Company by the customer, stating that the bill is past due and that the Company may terminate service unless the customer makes payments or contacts the Company to make arrangements for payments satisfactory to the Company.

<p>Issued: December 31, 2018</p> <p>Effective: January 1, 2019</p> <p>Advice Letter No.:</p>	<p>Issued by Justin Lee Brown Senior Vice President</p>	
--	---	--

RULE NO. 6

DISCONTINUANCE, TERMINATION, RESTORATION AND REFUSAL OF SERVICE
(Continued)

C. NOTICE REQUIREMENTS FOR TERMINATION OF SERVICE (Continued)

2. If the Company receives no response to the initial notice, a second notice will be presented to the customer at least 48 hours prior to the scheduled termination of service. This second notice may be:
 - a. Mailed by first class mail;
 - b. Communicated to the customer in person;
 - c. Communicated by telephone to a person who is 18 years of age or older and who is a resident at the address where the service is being provided;
 - d. Posted on the door of that residence if no one is home; or
 - e. If requested by the customer, electronically, via the Internet to the most recent electronic address provided to the Company by the customer.
3. The written notice shall include:
 - a. A termination warning in bold-faced type;
 - b. Address of proposed termination of service and identification of the account affected by the proposed termination;
 - c. Date on or after which such termination will occur;
 - d. Local address and telephone number of the Company;
 - e. The reason for the intended termination including, if the intended termination is for nonpayment, a statement designating the bill as one for actual or estimated use and specifying the total amount owed, the period over which that amount was incurred and the minimum payment required to avoid termination of service;

<p>Issued: December 31, 2018</p> <p>Effective: January 1, 2019</p> <p>Advice Letter No.:</p>	<p>Issued by Justin Lee Brown Senior Vice President</p>	
--	---	--

RULE NO. 6

DISCONTINUANCE, TERMINATION, RESTORATION AND REFUSAL OF SERVICE
(Continued)

C. NOTICE REQUIREMENTS FOR TERMINATION OF SERVICE (Continued)

3. The written notice shall include: (Continued)
- f. Procedure available to dispute the bill and the Company's willingness to promptly investigate the complaint and render its decision in writing to the customer;
 - g. Information advising the customer to contact the Consumer Division of the Commission (including the mailing address, telephone number and toll-free telephone number of the Commission) if the customer wishes to dispute any fact or interpretation of a regulation relied upon by the Company to terminate service;
 - h. Information advising the customer that service will not be terminated before the resolution of the dispute, if the customer pays the questioned portion of the bill to the Company at the time that the dispute arises and pays all subsequent bills;
 - i. An explanation of any arrangements for payment which the Company offers to customers having difficulty in paying their bills and a statement advising the customer to contact the Company for names, addresses and telephone numbers of government agencies or other organizations that have notified the Company that they will help customers who are unable to pay their bills;
 - j. An explanation of the conditions for postponing termination in accordance with Section D.1;

Issued:
November 10, 2009

Effective:
November 1, 2009

Advice Letter No.:

Issued by
John P. Hester
Senior Vice President

RULE NO. 6

DISCONTINUANCE, TERMINATION, RESTORATION AND REFUSAL OF SERVICE
(Continued)

C. NOTICE REQUIREMENTS FOR TERMINATION OF SERVICE (Continued)

3. The written notice shall include: (Continued)
- k. Information that elderly or disabled customers must notify the Company of their status as members of households which contain gas appliances essential for health; and
 - l. An explanation of the Company's reestablishment charge and procedures for reconnection.
4. When customers have notified the Company that they are elderly or disabled and require special assistance or that their household includes an elderly or disabled person, the Company shall contact such customer or another adult occupant of the service address, either in person or by telephone, at least 48 hours prior to the scheduled termination of service to explain all information as set forth in Section C.3 herein.

If the customer has given prior written notice to the Company designating a third-party to receive notification of any pending termination of service, the Company shall make a diligent effort to notify the third-party of the scheduled termination by sending the third-party a duplicate notice; however, the Company incurs no liability for failure to notify the third-party.

<p>Issued: December 31, 2018</p> <p>Effective: January 1, 2019</p> <p>Advice Letter No.:</p>	<p>Issued by Justin Lee Brown Senior Vice President</p>	
--	---	--

T
T

T

RULE NO. 6

DISCONTINUANCE, TERMINATION, RESTORATION AND REFUSAL OF SERVICE
(Continued)

D. CONDITIONS FOR TERMINATION POSTPONEMENT

1. Termination of service for nonpayment of a bill for service shall be postponed when termination to a residential customer or other permanent occupant would be especially dangerous to health. Service will be continued until the next regular billing if:
 - a. The Company receives a statement signed by the customer stating that said customer (1) is unable to pay for service in accordance with the Company's billing; and (2) is able to pay for service only in installments, the installment period of which shall not exceed 90 days.
 - b. A written statement from a licensed physician, public health official, or advanced practice registered nurse certifying the emergency is received within 5 days of first notification. The written statement certifying the emergency must contain:
 - (1) The service address affected;
 - (2) The name of the person whose health would be especially endangered by the proposed termination;
 - (3) A clear description of the nature of the emergency. The physician health official, or advanced practice registered nurse may consider feebleness, advanced age, physical disability, mental incapacity, serious illness or other infirmity of the person affected; and
 - (4) The name, title and signature of the person certifying the emergency.

<p>Issued: December 31, 2018</p> <p>Effective: January 1, 2019</p> <p>Advice Letter No.:</p>	<p>Issued by Justin Lee Brown Senior Vice President</p>	
--	---	--

T

T

T
T

RULE NO. 6

DISCONTINUANCE, TERMINATION, RESTORATION AND REFUSAL OF SERVICE
(Continued)

D. CONDITIONS FOR TERMINATION POSTPONEMENT *(Continued)*

1. *(Continued)*

- c. Postponement of the scheduled termination may be extended for an additional 30 days upon receipt by the Company of a renewed medical certificate prior to expiration of the original postponement. If the Company again intends to terminate service after a customer has obtained a *postponement of the scheduled termination, the Company shall give written notice of its intended action to the Consumer Relations Division of the Commission and to the customer and any other person required to receive notice in accordance with Sections C.1 and C.4 herein.*

Before expiration of the postponement, the customer must arrange with the Company to pay all bills that are due.

- 2. Termination of service for nonpayment of a bill for service will not occur when a residential customer enters into a written agreement with the Company, the terms of which are specified below, for the deferred payment of a delinquent bill.
 - a. Payment must be made within 90 days in four equal installments, with the first payment due upon the execution of the agreement; however, if the Company requires the payment of a deposit as a condition of continuing service, the delinquent bill and the deposit must be paid within 120 days in four equal payments.
 - b. All subsequent bills must be paid to the Company when due.
 - c. The Company shall consider any commitment by a governmental agency or its agent to assist customers who are unable to pay their bills.

<p>Issued: December 31, 2018</p> <p>Effective: January 1, 2019</p> <p>Advice Letter No.:</p>	<p>Issued by Justin Lee Brown Senior Vice President</p>	
--	---	--

RULE NO. 6

DISCONTINUANCE, TERMINATION, RESTORATION AND REFUSAL OF SERVICE
(Continued)

D. CONDITIONS FOR TERMINATION POSTPONEMENT (Continued)

2. (Continued)

- d. A customer may not initiate a program for deferred payment of a delinquent bill more than once during any 11 month period unless the Company otherwise agrees.
 - e. The service of a customer may be terminated without notice for any failure to comply with an existing agreement for deferred payment. If such termination occurs, the Company may require that the full amount of all bills for service be paid by the customer prior to restoration of service.
 - f. The agreement must specify the date on which each installment is due and contain a statement of the Company's right to terminate service should the customer fail to make payment as agreed.
3. Termination of service for nonpayment of a bill for service will not occur under any circumstances on the day prior to or on a national holiday or weekend.

E. RESTRICTIONS ON TERMINATION OF SERVICE

The Company may not terminate the service of a:

- 1. Residential customer because of the customer's failure to pay a delinquent bill for another class of service.
- 2. Customer because of delinquent bills which were incurred by a previous occupant of the location at which service is provided.

Issued:
December 31, 2018

Effective:
January 1, 2019

Advice Letter No.:

Issued by
Justin Lee Brown
Senior Vice President

T

T

T

RULE NO. 6

DISCONTINUANCE, TERMINATION, RESTORATION AND REFUSAL OF SERVICE
(Continued)

F. TERMINATION OF SERVICE BY COMPANY WITHOUT NOTICE

1. For Unsafe Apparatus or Where Service is Detrimental or Damaging to the Facilities or Services of the Company or its Customers

- a. If an unsafe or hazardous condition is found to exist on the customer's premises, or if the use of gas thereon by any gas piping, appliances, fixtures and apparatus of any kind or character beyond the point of delivery is found to be detrimental or damaging to the facilities or services of the Company or its customers, or if the utilization of gas by means thereof is prohibited or forbidden by law, the service may be terminated without notice. The Company shall notify the customer or occupant immediately of the reasons for the termination and the corrective action to be taken by the customer before service can be restored.
- b. Except for the Company's safety inspection under Rule 16.E, the Company has no duty to inspect the customer's premises or the customer's use of gas thereon by any gas piping, appliances, fixtures or apparatus of any kind or character and assumes no liability therefore.

2. For Service Detrimental to Other Customers. The Company will not establish or continue service to any customer who will or continues to operate equipment utilizing gas if the operation of such equipment will be or is detrimental to the service of the Company's other customers. This rule is for the Company's operating convenience and may not be invoked by any customer to terminate service to any other person on the basis of limited supply.

<p>Issued: December 31, 2018</p> <p>Effective: January 1, 2019</p> <p>Advice Letter No.:</p>	<p>Issued by Justin Lee Brown Senior Vice President</p>	
--	---	--

RULE NO. 6

DISCONTINUANCE, TERMINATION, RESTORATION AND REFUSAL OF SERVICE
(Continued)

F. TERMINATION OF SERVICE BY COMPANY WITHOUT NOTICE (Continued)

3. For Fraud. The Company shall have the right to refuse or to terminate service if the acts of the customer or the conditions upon such customer's premises are such as to indicate intention to defraud the Company. When the Company has discovered that a customer has obtained service by fraudulent means, or has used the service for unauthorized purposes, the service to that customer may be terminated without notice. The Company will not restore service to such customer until that customer has complied with all filed rules and reasonable requirements of the Company and the Company has been reimbursed for the full amount of the service rendered and the actual cost to the Company incurred by reason of the fraudulent use.

4. For Failure to Meet Credit Requirements or Make an Installment Payment on a Delinquent Bill. If, for the convenience of an applicant, the Company should establish service to an applicant before credit has been established, the Company may terminate service if the customer (applicant) fails to establish credit within 10 working days thereafter. Where the customer has agreed to make installment payments on a security deposit, the Company may terminate service without notice for any failure to pay the deposit as agreed.

The service of a customer who enters into an agreement to make installment payments on a delinquent bill may also be terminated without notice for any failure to make payment as provided by the agreement.

5. For Failure of Guarantor to Assume Liability. If a guarantor is required to make any payment for a customer for whom the guarantor is acting and fails to make the required payment within a period not to exceed three months, the Company may terminate service to the guarantor without notice.

<p>Issued: December 31, 2018</p> <p>Effective: January 1, 2019</p> <p>Advice Letter No.:</p>	<p>Issue by Justin Lee Brown Senior Vice President</p>	
--	--	--

RULE NO. 6

DISCONTINUANCE, TERMINATION, RESTORATION AND REFUSAL OF SERVICE
(Continued)

F. TERMINATION OF SERVICE BY COMPANY WITHOUT NOTICE *(Continued)*

6. Upon an order of any court or the Commission.
7. If an event that cannot be reasonably anticipated or controlled (a force majeure) occurs which requires termination of service.
8. If the location at which service is provided has been abandoned.
9. If the Company has tried diligently to serve notice in accordance with Section C hereof but has been unable to give such a notice.

G. RESTORATION OF SERVICE

1. Reestablishment. The Company shall restore service to a customer as soon as conditions permit:
 - a. When the customer has complied with all rules pertaining to payments, deposits, safety and other requirements;
 - b. Upon the order of any court of competent jurisdiction or the Commission; or
 - c. Upon the receipt of a statement from a licensed physician, public health official, or advanced practice registered nurse certifying that termination of service has constituted an emergency affecting the health of the customer or another person who is a permanent resident of the premises where service has been terminated.
2. Natural gas service to a mobile home park having a master meter or a multi-family complex will be prioritized ahead of all other scheduled service orders, except for emergencies.

<p>Issued: June 16, 2017</p> <p>Effective: September 27, 2017</p> <p>Advice Letter No.: 506</p>	<p>Issued by Justin Lee Brown Vice President</p>	
--	--	--

RULE NO. 6

DISCONTINUANCE, TERMINATION, RESTORATION AND REFUSAL OF SERVICE
(Continued)

G. RESTORATION OF SERVICE *(Continued)*

3. Reestablishment Charge. Where service has been terminated for violation of these rules or for nonpayment of bills, the Company will charge a reestablishment charge at the same rate as the service establishment charge as set forth in the currently effective Statement of Rates of this Nevada Gas Tariff.

H. REFUSAL TO SERVE

1. The Company may refuse to provide service to an applicant or customer under any of the following conditions:
 - a. If the applicant or customer fails to comply with any of the rules of the Company as filed with the Commission;
 - b. If the intended use of the service is of such a nature that it will be detrimental or injurious to existing customers in accordance with Sections F.1 and F.2. herein;
 - c. If, in the judgment of the Company, the applicant's installation for utilizing the service is unsafe or hazardous or of such nature that satisfactory service cannot be rendered;
 - d. Where service has been terminated for fraudulent use, in which case Section F.3 herein will apply; or
 - e. If the customer is delinquent in the payment of bills presented to the customer by the Company.
2. Notification to Applicants or Customers. When an applicant or customer is refused service or service has been terminated under the provisions of this rule, the Company will notify the applicant or customer of the reasons for the refusal to provide service and of the right of the applicant or customer to appeal the Company's decision to the Commission.

<p>Issued: December 31, 2018</p> <p>Effective: January 1, 2019</p> <p>Advice Letter No.:</p>	<p>Issued by Justin Lee Brown Senior Vice President</p>	
--	---	--

RULE NO. 7

INFORMATION AVAILABLE TO THE PUBLIC

A. GENERAL INFORMATION

The Company will maintain on file at each of its offices at which an agent is employed (except agents maintained for collection only) all of its rules and schedules of rates applying at such office or district and will also maintain on file at its principal place of business all of its rules and schedules of rates. All rules and schedules of rates will be kept available for public inspection or examination at all reasonable times. At the time a customer commences service, such customer will be provided with the rate schedule applicable to the customer.

B. GAS CONSUMPTION

The Company, at the request of a customer, shall furnish such customer with a statement of the customer's actual gas consumption for each billing period during the prior year at the location where service is provided.

C. OPTIONAL RATES

When two or more rate schedules are applicable to the same class of service, each will be called to an applicant's attention, who must then designate on the application form the one under which the applicant elects to be billed.

D. NEW OR REVISED RATES

In the event of the adoption by the Company of new or optional schedules of rates, the Company will take such measures as may be practicable to advise those of its customers who may be affected that such new or optional rates are effective, as set forth in the particular schedules. Legal notice at the time any such new schedule or new rates are proposed shall be considered to be adequate notice pursuant to this section.

<p>Issued: December 31, 2018</p> <p>Effective: January 1, 2019</p> <p>Advice Letter No.:</p>	<p>Issued by Justin Lee Brown Senior Vice President</p>	
--	---	--

RULE NO. 7

INFORMATION AVAILABLE TO THE PUBLIC
(Continued)

E. CUSTOMER COMPLAINT FORM

The Company shall make available to the customer a standard form to be used for the purpose of making written complaints to the Company. Such form shall be available at each of the Company's business offices.

F. CHANGE OF RATE SCHEDULE BY CUSTOMER

Should a customer be eligible and elect to take service under a different applicable rate schedule, the change will become effective after the regular meter reading next following the date of such request. The Company may refuse to permit such a change unless service has been taken under the current rate schedule for a period of not less than 12 months, except customers served under Schedule No. SG-OS/NG-OS need only have taken such service for a period of not less than six months. The Company will permit a change of rate schedule by a customer when an applicable new or revised rate schedule is first put into effect or the customer's operations have changed so as to justify immediate transfer to a different schedule.

<p>Issued: December 31, 2018</p> <p>Effective: January 1, 2019</p> <p>Advice Letter No.:</p>	<p>Issued by Justin Lee Brown Senior Vice President</p>	
--	---	--

T
T

T

RULE NO. 8

CONTINUITY OF SERVICE

A. EMERGENCY INTERRUPTION

The Company will exercise reasonable diligence to furnish a continuous and sufficient supply of gas to its customers and to avoid any shortage or interruption of delivery thereof. It cannot, however, guarantee complete freedom from interruption.

The Company will not be liable for interruptions or shortages of supply, nor for any loss or damage occasioned thereby, whether such interruptions or shortages occurred with or without notice to the customer.

B. TEMPORARY SUSPENSION FOR REPAIRS

The Company has the right to suspend service temporarily for the purpose of making necessary repairs or improvements to its system. When this becomes necessary, it will endeavor to give the customers who may be affected as reasonable notice thereof as circumstances will permit and will prosecute the work with reasonable diligence.

C. APPORTIONMENT OF SUPPLY DURING TIME OF SHORTAGE

1. Supply Shortages. During times of shortage of supply, the Company will apportion the supply of gas (which term includes natural gas and all substitutes therefore) available to it among its customers in accordance with NAC 704.501. Irrespective of the immediate availability to it of any quantities of gas, the Company, in its operating judgment, shall have the authority to withhold any or all such quantities from immediate delivery for the purpose of injecting such quantities into storage or retaining them in storage provided, however, that unless the Commission shall direct the Company to the contrary, the Company shall not withhold delivery of immediately available quantities of gas to any customers in Priority 1 and Priority 2 except in accordance with the provisions of NAC 704.501. A shortage of supply for the purposes of this paragraph shall be deemed to exist when the Company shall have insufficient quantities of gas available to meet the requirements of all of its customers together with its own requirements for storage.

<p>Issued: December 31, 2018</p> <p>Effective: January 1, 2019</p> <p>Advice Letter No.:</p>	<p>Issued by Justin Lee Brown Senior Vice President</p>	
--	---	--

RULE NO. 8

CONTINUITY OF SERVICE
(Continued)

C. APPORTIONMENT OF SUPPLY DURING TIME OF SHORTAGE (Continued)

2. Order of Curtailment

- a. The order of curtailment shall be in inverse order of the curtailment priorities set forth in NAC 704.501.
- b. Curtailment priorities shall apply to both sales customers and transportation customers.
- c. Customers electing service under Schedule No. SG-AS/NG-AS will be curtailed first, followed by customers served under discounted transportation or sales rates, followed by all other transportation and sales customers. Customers paying the least under discounted transportation or sales rates will be curtailed first within an affected priority.
- d. Each priority shall be curtailed in full before the next priority in order is curtailed.
- e. When Priority 1 customers would be curtailed due to system supply failure (either upstream capacity or supply failure), the Company is authorized to "preempt" deliveries of lower priority (numerically higher priority number) transportation customers' gas and divert such supplies to the otherwise affected Priority 1 customers. Affected transportation customers will be curtailed to the same extent as sales customers of the same priority. Such transportation customers will be compensated for the preemption of their gas supplies.

Issued:
November 10, 2009

Effective:
November 1, 2009

Advice Letter No.:

Issued by
John P. Hester
Senior Vice President

RULE NO. 8

CONTINUITY OF SERVICE
(Continued)

C. APPORTIONMENT OF SUPPLY DURING TIME OF SHORTAGE (Continued)

2. Order of Curtailment (Continued)

- f. The installation of a cogeneration facility shall not affect the underlying end use priority of the establishment.
- g. Natural gas utilized as compressed natural gas for vehicle fuel shall be classified as a commercial end use.
- h. Application of curtailment priorities will normally be done on a scheduled basis as part of the daily gas requirement nomination and confirmation routine. Operational emergency curtailment will conform to these priorities to the extent possible and practicable.
- i. In accordance with the provisions set forth in Sections 6.13 of Schedule No. ST-1/NT-1, a transportation customer may be curtailed to the level of actual supply scheduled for that customer, regardless of end use priority.

D. DISASTER CONDITIONS

Under disaster conditions, the Company will cooperate to the fullest extent with the governmental agency having authority in the area.

<p>Issued: December 31, 2018</p> <p>Effective: January 1, 2019</p> <p>Advice Letter No.:</p>	<p>Issued by Justin Lee Brown Senior Vice President</p>	
--	---	--

D

T

RULE NO. 9

FACILITIES EXTENSIONS

Extensions of gas mains (mains), distribution service lines (services), meter set assemblies, regulators and other appurtenant device(s) necessary to furnish permanent service to applicants will be made in accordance with this rule.

A. GENERAL

1. The Company will construct, own, operate and maintain main and service extensions.
 - a. Main extensions will be of suitable capacity and installed only along public streets, roads, and highways which the Company has legal right to occupy, and on public lands and private property across which rights-of-way are satisfactory to the Company.
 - b. Service extensions will be of suitable capacity from the Company's gas main to a meter location on the property of the applicant that is satisfactory to the Company.
2. Gas main and service extensions will be made by the Company at its expense, provided the total estimated cost of the extension, less any cash or non-cash contribution in aid of construction (contribution), does not exceed the allowable investment. Non-cash contributions include, but are not limited to, customer provided trench. The Company may require the applicant to provide an advance of the allowable investment guaranteeing bona fide operation of the customer's facilities for which the extension is requested. Additionally, main and service extensions to and within individually metered subdivisions, housing projects, multi-family dwellings, and mobile home parks or estates will be made only when the entire estimated cost of such extensions (as determined by the Company), less contributions, is advanced to the Company. Contributions and advances may be adjusted to recover the cost of federal income taxes in accordance with the NAC. At its option, the Company may accept a performance bond or other security in lieu of an advance.

<p>Issued: December 31, 2018</p> <p>Effective: January 1, 2019</p> <p>Advice Letter No.:</p>	<p>Issued by Justin Lee Brown Senior Vice President</p>	
--	---	--

RULE NO. 9

FACILITIES EXTENSIONS

(Continued)

A. GENERAL *(Continued)*

3. Each applicant for a main and/or service extension will be required to execute a contract covering the terms under which the Company will install extensions, including, but not limited to, a description of the natural gas equipment to be used. If no identifiable load is available, it will be noted on the contract.
4. The Company will not install more than one service extension to supply a single premise, except at the option of the Company for its operating convenience or necessity.
5. Where service is provided to a meter location on private property, which is subsequently subdivided into multiple premises with ownership of portions thereof divested to multiple entities, the Company shall have the right, upon written notice, to discontinue service without obligation or liability. Gas service, will be reestablished in accordance with the applicable provisions of the Company's Nevada Gas Tariff.
6. The length of the main/service required for an extension will be considered as the distance along the shortest practical available route, as determined by the Company.
7. When, in the judgment of the Company, providing natural gas service to an applicant would impair service to other customers, the cost of necessary reinforcement to eliminate such impairment which is not included in the allowable investment will be collected at the time the contract is executed.
8. Subject to any customer advance or contribution requirements, the installation of an excess flow valve shall be performed by the Company at the Company's expense on new or replaced single residence service lines. If a customer requests the installation of an excess flow valve where one would not otherwise be provided by this rule, the Company shall perform the installation subject to the feasibility of such installation and at the customer's expense.

<p>Issued: December 31, 2018 Effective: January 1, 2019 Advice Letter No.:</p>	<p>Issued by Justin Lee Brown Senior Vice President</p>	
--	---	--

RULE NO. 9

FACILITIES EXTENSIONS

(Continued)

A. GENERAL *(Continued)*

9. The cost of relocating mains and/or services at the customer/applicant request will be performed at the expense of the customer/applicant. The cost of main and/or service work performed may be adjusted to recover the cost of federal income taxes in accordance with the NAC.
10. Relocation of facilities will be mandatory and at the customer's expense when actions of the customer restrict the Company's access to, or the safety of the facilities. Should access not be given to the Company, service may be terminated at the Company's discretion.
11. Investments in main and/or service extensions are made by the Company on the basis of economic feasibility. Economically feasible means, the cost to install and operate an incremental investment in mains and/or services is supported by the revenue to be derived from the related incremental investment. Economic feasibility will be determined using the Incremental Contribution Method (ICM).
12. In unusual circumstances, when the application of this rule appears impractical or unjust to either party, the Company or the applicant may refer the matter to the Commission for special ruling or for the approval of special conditions which may be mutually agreed upon, prior to commencing construction.
13. Branch Services. The Company, at its option, may install a branch service for units on adjoining premises.

<p>Issued: December 31, 2018</p> <p>Effective: January 1, 2019</p> <p>Advice Letter No.:</p>	<p>Issued by Justin Lee Brown Senior Vice President</p>	
--	---	--

RULE NO. 9

FACILITIES EXTENSIONS

(Continued)

B. ALLOWABLE INVESTMENT

Allowable investment is the maximum amount that the Company will invest in new facilities such that the revenues derived from the new facilities provides a rate of return on the Company's investment no less than the overall rate of return authorized by the Commission in the Company's most recent general rate case.

1. Incremental Contribution Method - The ICM is a cost of service analysis used to calculate the expected rate of return on an investment in mains and/or services and related facilities.
 - a. If the ICM analysis results show a rate of return equal to or greater than the overall rate of return authorized by the Commission in the Company's most recent general rate case, the allowable investment is equal to the cost of the incremental investment.
 - b. The Company may extend facilities to applicants whose facilities extension does not satisfy the economic feasibility test, provided such applicant signs an extension agreement agreeing to provide a nonrefundable contribution and/or a refundable advance necessary to limit the Company's investment in the extension to the allowable investment. Any contribution or advance may be adjusted to recover the cost of federal income taxes in accordance with the NAC.
 - c. The Company, at its option, may postpone that portion of an advance which it estimates would be refunded within 12 months under the provisions of this rule. The Company may require the applicant to provide a surety bond or other Company approved surety equal to the amount of the postponed advance. At the end of the postponement period, the Company shall collect all such amounts not previously advanced which are not then refundable. When advances are postponed, the applicant may be required to furnish to the Company evidence of the necessary approvals to commence construction and of adequate financing.

<p>Issued: December 31, 2018</p> <p>Effective: January 1, 2019</p> <p>Advice Letter No.:</p>	<p>Issued by Justin Lee Brown Senior Vice President</p>	
--	---	--

RULE NO. 9

FACILITIES EXTENSIONS

(Continued)

B. ALLOWABLE INVESTMENT *(Continued)*

2. If any applicant fails to take service in amounts stated as the basis for estimating the allowable investment, the Company may calculate and bill the customer a nonrefundable Facilities Charge. The Facilities Charge will be equal to the unpaid contribution necessary for the Company to achieve the authorized rate of return according to the Company's extension rule in effect at the time the extension was made, as though service had been requested on the basis of the actual equipment installed and utilized.

Issued:

December 31, 2018

Effective:

January 1, 2019

Advice Letter No.:

Issued by
Justin Lee Brown
Senior Vice President

D
T

T

RULE NO. 9

FACILITIES EXTENSIONS

(Continued)

C. REFUND OF ADVANCES

Amounts advanced by the applicant in accordance with this rule, less any unpaid Facility Charges, shall be refunded, without interest, under the following conditions:

1. Refunds of advances, including any amounts collected to recover the cost of federal income taxes, shall be made for each additional verified incremental permanent load connected to the extension for which an advance was collected.
2. Refunds will be made annually, or intermittently within the annual period at the option of the Company. Amounts refunded may be accumulated to a minimum of \$50, or the total refundable balance if less than \$50.
3. When two or more parties make a joint advance on the same extension, refundable amounts will be distributed to these parties in the same proportion as their individual percentages of the total joint advance.
4. The refund period shall be ten years from the date of the completion of the extension, or a period mutually agreed upon by the Company and the applicant.
5. Any assignment by a customer of their interest in any part of an advance must be made in writing and approved by the Company.
6. Amounts advanced under an extension rule previously in effect will be refunded in accordance with the provisions of such rule.

<p>Issued: June 16, 2017</p> <p>Effective: September 27, 2017</p> <p>Advice Letter No.: 506</p>	<p>Issued by Justin Lee Brown Vice President</p>	
--	--	--

RULE NO. 9

FACILITIES EXTENSIONS

(Continued)

C. REFUND OF ADVANCES (Continued)

7. When a project is constructed in consecutive phases such that each phase is constructed separately and requires separate advances, unused allowances from one phase may be applied to an outstanding advance in any other phase of that project so long as such outstanding advance is still eligible for refund.

Issued:
June 16, 2017

Effective:
September 27, 2017

Advice Letter No.:
506

Issued by
Justin Lee Brown
Vice President

T

T
T

RULE NO. 9

FACILITIES EXTENSIONS

(Continued)

D. RESIDENTIAL AMORTIZATION PROGRAM

The program shall be available for one or more residential customers which are judged to be of a permanent and continuing nature. Pursuant to the program, main and service line extension contracts may be established to amortize that portion of an extension project's cost in excess of the Company's allowable investment. The amortization will appear as a monthly surcharge on the participating customer's bill.

Amortization of the customer contribution toward a given line extension project shall be offered in those cases where all of the following criteria are satisfied:

1. There exists reasonable certainty that both the Company's allowable investment and the amortized customer contribution can be recovered in their entirety;
2. The customer contribution toward a given line extension project represents a significant amount if paid as a lump sum and would present an undue burden upon the customer; and
3. The price of gas service, including amortization of the facilities charge, calculated on the basis of a term of four years, is demonstrated to be less than 75 percent of the customer's annualized alternative fuel costs.

In those instances in which service is extended to an area where five or less customers take service, the Company may condition the extension on the customer agreeing to be individually obligated for their share of the cost in excess of the allowable investment.

For those customers not qualifying for an amortization program pursuant to the criteria specified herein, the Company may, at its discretion, establish a main and service line extension contract to amortize that portion of an extension project's costs in excess of the Company's allowable investment.

<p>Issued: December 31, 2018</p> <p>Effective: January 1, 2019</p> <p>Advice Letter No.:</p>	<p>Issued by Justin Lee Brown Senior Vice President</p>	
--	---	--

RULE NO. 9

FACILITIES EXTENSIONS

(Continued)

D. RESIDENTIAL AMORTIZATION PROGRAM (Continued)

The Company will make its decision on whether to offer amortization of a project's line extension expense on a case-by-case basis considering the following criteria:

1. The magnitude of the amount of the line extension cost for which the customer is responsible;
2. The degree of certainty with which the Company may recover the line extension costs that it permits a group of customers to amortize; and
3. The ability of the Company to recover its allowable investment over the life of the facilities.

The amortization period of the aforementioned contract shall not exceed five years. The customer's contribution toward the excess line extension project shall constitute the principal of the contract. The capital costs in excess of the allowable investment shall not be treated as a component of the Company's plant in service included in rate base either during the amortization period, or after its termination. The customer's monthly surcharge shall be determined by dividing the contract's principal by the product of: (a) the anticipated number of months over which the customer contribution is amortized, and (b) the number of customers to be served by the line extension project. All monthly surcharge revenue shall be used to reimburse the Company for the capital costs in excess of the free allowance. No interest shall be applied to the principal.

The Company shall submit to the Commission an informational filing upon the initiation of such a project which will specify:

1. A general description of the area to be served;
2. The number of customers projected to be served;
3. The total capital costs;

<p>Issued: December 31, 2018</p> <p>Effective: January 1, 2019</p> <p>Advice Letter No.:</p>	<p>Issued by Justin Lee Brown Senior Vice President</p>	
--	---	--

RULE NO. 9

FACILITIES EXTENSIONS

(Continued)

D. RESIDENTIAL AMORTIZATION PROGRAM (Continued)

4. The amount of allowable investment;
5. The customer contribution;
6. The anticipated number of months over which the customer contribution is to be amortized;
7. The amount of the amortization surcharge to be assessed;
8. A copy of the service contract being utilized; and
9. A copy of the economic analysis which has been performed regarding the project in question.

If a customer that is a party to a residential amortization program contract should disconnect service, and later reconnect at the same service address, the customer shall pay the Company the sum of any unpaid monthly surcharges accrued during the period of disconnection before service shall be reestablished.

If an additional applicant requests service which requires connection to a line extension that is already subject to an amortization program, such additional applicant shall, in addition to any incremental contribution requirement, pay the monthly surcharge provided in the amortization program contract.

The monthly surcharge in the final month of the amortization period shall be adjusted to account for any change in the estimated number of customers, such that the sum of charges paid over the term of the contract equals the principal. The final payment shall not exceed the level of the surcharge assessed during the term prior to the final payment. Any excess collections shall be refunded equally to all customers of record at the time the refund is distributed.

Issued:

May 4, 2011

Effective:

August 10, 2011

Advice Letter No.:

468

Issued by
John P. Hester
Senior Vice President

RULE NO. 9

FACILITIES EXTENSIONS

(Continued)

D. RESIDENTIAL AMORTIZATION PROGRAM *(Continued)*

In instances where an owner or tenant that was a party to such a line extension contract moves from a service address before expiration of the contract, a new owner or tenant requesting gas service shall be subject to the monthly surcharge for as long as the new owner or tenant resides at that address, until such time as the contract expires.

The Basic Service Charge and margin revenues associated with each project must be sufficient to at least cover the cost of federal income taxes on the surcharge revenues.

The residential amortization plan shall only be applicable to one or more direct residential customers and shall not be available to developers, contractors or other commercial entities.

E. EXCESS FLOW VALVE AND SERVICE LINE SHUT-OFF VALVE INSTALLATION

Subject to any customer advance or contribution requirements, the installation of an Excess Flow Valve (EFV) or a Service Line Shut-Off Valve (SLSV) shall be performed on all newly installed or replaced service lines connected to the Utility's distribution system before the service is activated as provided by this Rule. Nothing in this Rule prevents the Company from installing or specifying, in its sole discretion, the installation of an EFV or an SLSV in additional service types.

1. Applicable service line types:

- a. A service line to a Single-Family Residential Structure;
- b. A branch service to a Single-Family Residential Structure installed concurrently with the primary Single-Family Residential Structure service line (i.e., a single EFV may be installed to protect both service lines);

<p>Issued: December 31, 2018</p> <p>Effective: January 1, 2019</p> <p>Advice Letter No.:</p>	<p>Issued by Justin Lee Brown Senior Vice President</p>	
--	---	--

RULE NO. 9

FACILITIES EXTENSIONS

(Continued)

E. EXCESS FLOW VALVE AND SERVICE LINE SHUT-OFF VALVE INSTALLATION

(Continued)

3. Except as provided by Rule 9.E.1.e, where it is necessary to install, change or alter the EFV, due to a Customer's request, an alteration of the Customer's premises, or alteration of the Customer's load, the Customer shall reimburse the Company for all expenses in connection with upgrading or removing the EFV.
4. Customers have the right to request the installation of an EFV on their existing service line if the load does not exceed 5,500 SCFH and the conditions in Section 2 are not present.
5. If a customer requests the installation of an EFV on their existing service, the Company shall perform the installation subject to the feasibility of such installation and at a mutually agreeable date.
6. The customer's financial contribution towards the cost of a customer requested installation of an EFV is shown in the Statement of Rates – Other Service Charges

Issued:

May 18, 2017

Effective:

Aug 16, 2017

Advice Letter No.:

504

Issued by
Justin Lee Brown
Vice President

N
N
T
T

SOUTHWEST GAS CORPORATION
P.O. Box 98510
Las Vegas, Nevada 89193-8510
Nevada Gas Tariff No. 7

Canceling 2nd Revised P.U.C.N. Sheet No. 194
1st Revised P.U.C.N. Sheet No. 194

HELD FOR FUTURE USE

Issued:

May 4, 2011

Effective:

August 10, 2011

Advice Letter No.:

468

Issued by
John P. Hester
Senior Vice President

SOUTHWEST GAS CORPORATION
P.O. Box 98510
Las Vegas, Nevada 89193-8510
Nevada Gas Tariff No. 7

Canceling 1st Revised P.U.C.N. Sheet No. 195-198
Original P.U.C.N. Sheet No. _____

HELD FOR FUTURE USE

Issued:

May 4, 2011

Effective:

August 10, 2011

Advice Letter No.:

468

Issued by
John P. Hester
Senior Vice President

SOUTHWEST GAS CORPORATION
P.O. Box 98510
Las Vegas, Nevada 89193-8510
Nevada Gas Tariff No. 7

Canceling 2nd Revised P.U.C.N. Sheet No. 199-200
1st Revised P.U.C.N. Sheet No. _____

HELD FOR FUTURE USE

Issued:

May 4, 2011

Effective:

August 10, 2011

Advice Letter No.:

468

Issued by
John P. Hester
Senior Vice President

SOUTHWEST GAS CORPORATION
P.O. Box 98510
Las Vegas, Nevada 89193-8510
Nevada Gas Tariff No. 7

Canceling 1st Revised P.U.C.N. Sheet No. 201
Original P.U.C.N. Sheet No. 201

HELD FOR FUTURE USE

Issued:

May 4, 2011

Effective:

August 10, 2011

Advice Letter No.:

468

Issued by
John P. Hester
Senior Vice President

SOUTHWEST GAS CORPORATION
P.O. Box 98510
Las Vegas, Nevada 89193-8510
Nevada Gas Tariff No. 7

Canceling 2nd Revised P.U.C.N. Sheet No. 202
1st Revised P.U.C.N. Sheet No. 202

HELD FOR FUTURE USE

Issued:

May 4, 2011

Effective:

August 10, 2011

Advice Letter No.:

468

Issued by
John P. Hester
Senior Vice President

RULE NO. 11

INFORMATION ON FORMS

A. CUSTOMER'S BILLS

Each bill for service will contain a statement to the effect that this bill is now due and payable.

B. CUSTOMER'S DEPOSIT RECEIPT

Each receipt for cash deposit made to establish credit pursuant to Rule No. 13 of this Nevada Gas Tariff will contain a statement to the effect that, this deposit, less the amount of unpaid bills, will be refunded, together with any interest due upon discontinuance of service, in accordance with Rule No. 13.

<p>Issued: December 31, 2018</p> <p>Effective: January 1, 2019</p> <p>Advice Letter No.:</p>	<p>Issued by Justin Lee Brown Senior Vice President</p>	
--	---	--

RULE NO. 12

ESTABLISHMENT AND REESTABLISHMENT OF CREDIT

A. ESTABLISHMENT OF CREDIT

Each applicant, as a condition of service, will be required to satisfactorily establish credit.

1. An applicant for residential service may establish credit if the applicant:
 - a. Submits payment of a cash deposit to ensure the payment of a bill issued for service, as prescribed in Rule No. 13;
 - b. Provides consent to a soft credit check with the Utility credit bureau vendor and receives an adequate creditworthiness designation;
 - c. Has been a customer of the Company within the preceding two years and has established satisfactory credit;
 - d. Has been a customer of a municipal or any other regulated energy Company within the preceding two years and has made timely payment of each bill issued for service during the 12 months immediately preceding the applicant's request for service;
 - e. Uses a guarantor who must:
 - (1) Be a customer of the Company with satisfactory credit;
 - (2) Assume liability for the customer for whom guarantor is acting for an amount not to exceed the amount of the deposit that the customer otherwise would have been required to pay and for a period not to extend past the date the deposit otherwise would have been required to be refunded; and
 - (3) Make payment for the customer for whom guarantor is acting, in the event guarantor is required to make such payment, within a period not to exceed three months. If payment is not made within this period, the Company may terminate service to the guarantor without notice.

Issued:
February 17, 2021

Effective:
May 1, 2021

Advice Letter No.:
522

Issued by
Justin Lee Brown
Senior Vice President

RULE NO. 12

ESTABLISHMENT AND REESTABLISHMENT OF CREDIT
(Continued)

A. ESTABLISHMENT OF CREDIT *(Continued)*

1. *(Continued)*
 - e. Receives benefits from a retirement plan or the Social Security Administration; or
 - f. Has otherwise established credit acceptable to the Company.
2. An applicant for nonresidential service may establish credit if the applicant:
 - a. For amounts not exceeding \$5,000, submits payment of a cash deposit to ensure the payment of a bill issued for service, as prescribed in Rule No. 13;
 - b. Furnishes a surety bond, letter of credit, or other means acceptable to the Company for payment to the Company of a sum equal to the required deposit; or
 - c. Has otherwise established credit acceptable to the Company.

B. REESTABLISHMENT OF CREDIT

1. Former Customers. An applicant who has been a customer of the Company and who is indebted to the Company will be required to reestablish credit by paying all delinquent bills (unless collection of such debt is barred by law) and by depositing the amount prescribed in Rule No. 13.
2. Present Customers
 - a. A customer whose gas service has been terminated for nonpayment of bills for gas service will be required, before such service is restored, to reestablish credit by paying all delinquent bills (unless collection of such debt is barred by law) and by depositing the amount prescribed in Rule No. 13.

<p>Issued: December 31, 2018</p> <p>Effective: January 1, 2019</p> <p>Advice Letter No.:</p>	<p>Issued by Justin Lee Brown Senior Vice President</p>	
--	---	--

RULE NO. 12

ESTABLISHMENT AND REESTABLISHMENT OF CREDIT
(Continued)

B. REESTABLISHMENT OF CREDIT (Continued)

2. Present Customers (Continued)

- b. A nonresidential customer who is delinquent in the payment of a bill for gas service may be required to reestablish credit by depositing the amount prescribed in Rule No. 13.
- c. A customer who, in establishing credit, was not required to provide a deposit, may be required to reestablish credit by providing a deposit in the amount prescribed in Rule No. 13 once credit has become unsatisfactory.
- d. A customer who is subject to termination of service and who requests the continuation of service may be required to provide a deposit in addition to any other deposit made by customer pursuant to Rule No. 13 only if the initial deposit has been returned to the customer or more than one-half (½) of the deposit has been applied to the account of the customer. In no event will the deposit held by the Company exceed the amounts prescribed in Rule No. 13.
- e. A customer who, as a result of receiving benefits from a retirement plan or the Social Security Administration, is exempt from providing a deposit to establish credit may be required to reestablish credit by providing a deposit in the amount prescribed in Rule No. 13 if the customer has established unsatisfactory credit.
- f. An elderly customer who initially established credit by providing the required deposit as prescribed in Rule No. 13 and has since established unsatisfactory credit may be required to reestablish credit by providing an additional deposit amount as prescribed in Rule No. 13.

Issued:
November 10, 2009

Effective:
November 1, 2009

Advice Letter No.:

Issued by
John P. Hester
Senior Vice President

RULE NO. 12

ESTABLISHMENT AND REESTABLISHMENT OF CREDIT
(Continued)

C. SPECIAL CONDITION

Request for residential service will not be denied for reason of delinquent billing for other classes of service.

Issued:
November 10, 2009

Effective:
November 1, 2009

Advice Letter No.:

Issued by
John P. Hester
Senior Vice President

RULE NO. 13

DEPOSITS

A. PURPOSE

The security deposit required under Rule No. 12 of this Nevada Gas Tariff for each service provided by the Company represents a pledge by an applicant or customer to make future payments to the Company and not payment for future services that are furnished by the Company.

B. AMOUNT TO ESTABLISH OR REESTABLISH CREDIT

1. Residential Customers

- a. An amount not to exceed one and one-half (1½) times the estimated average monthly bill of the customer; however, if service is terminated, the deposit required by the Company to restore service shall be an amount not to exceed one and one-half (1½) times the estimated average monthly bill of the customer.
- b. For the elderly, an amount not to exceed one-half (½) of the deposit established in Section B.1.a. hereof; however, if the customer has established unsatisfactory credit, the Company may require such customer to pay the full amount of the deposit prescribed in Section B.1.a. herein.
- c. For any customer who has been granted a deposit waiver or whose deposit has been refunded and has since established unsatisfactory credit, an amount not to exceed the deposit required in Section B.1.a. herein.

- 2. Nonresidential Customers. An amount not to exceed twice the estimated maximum monthly bill of the customer.

<p>Issued: December 31, 2018</p> <p>Effective: January 1, 2019</p> <p>Advice Letter No.:</p>	<p>Issued by Justin Lee Brown Senior Vice President</p>	
--	---	--

RULE NO. 13

DEPOSITS
(Continued)

B. AMOUNT TO ESTABLISH OR REESTABLISH CREDIT (Continued)

3. Adjustment of Amount of Deposit. The amount of the deposit may be reviewed from time to time at the request of the Company or the customer and adjusted, if necessary, to conform to actual billing experience. The Company may also utilize a customer's payment history as a basis for determining whether the customer meets the requirements of Satisfactory Credit, as defined in Rule 1 of the Nevada Gas Tariff. If the customer does not meet the requirements of Satisfactory Credit, the Company may adjust the amount of a customer deposit or, in the absence of a deposit, require one. In any event, the amount of a deposit shall not exceed the amounts prescribed herein.

C. PRIOR NOTICE OF DEPOSIT REQUIREMENT

If the Company is to require a deposit from an elderly customer or a customer receiving retirement or Social Security benefits, the Company shall notify such customer after the third late payment that an additional deposit or a new deposit, whichever is applicable, may be required after the fourth late payment.

D. DEFERRED PAYMENT PLAN FOR PAYMENT OF DEPOSITS

1. A residential customer who is required to pay a deposit of \$50 or more to establish or reestablish credit shall be permitted to enter into a written agreement with the Company for payment of the deposit in three installments as specified below:
 - a. An amount equal to one-third (1/3) of the deposit prior to service being provided.
 - b. The remainder of the deposit, in two equal installments, not later than 30 and 60 days, respectively, after the date of the agreement.

If the required deposit is less than \$50, such customer shall be permitted to defer payment of the deposit for 30 days.

<p>Issued: December 31, 2018</p> <p>Effective: January 1, 2019</p> <p>Advice Letter No.:</p>	<p>Issued by Justin Lee Brown Senior Vice President</p>	
--	---	--

RULE NO. 13

DEPOSITS
(Continued)

D. DEFERRED PAYMENT PLAN FOR PAYMENT OF DEPOSITS (Continued)

2. The customer may be required to pay interest, at a rate set forth in this Nevada Gas Tariff, on the unpaid portion of the deposit.
3. The service of the customer may be terminated without notice for any failure to pay the deposit as agreed and, in such a case, the customer may be required to pay the full amount of the deposit, plus any other money owed the Company, before service is restored.
4. The agreement must specify the date on which each installment is due and contain a statement of the provisions as specified herein. The right of the Company to terminate the service of the customer for any failure to pay the deposit must be stated in bold-faced type on the agreement.

E. DEFERRED PAYMENT PLAN FOR PAYMENT OF DEPOSIT WITH ARREARAGE

A residential customer who enters into an agreement for the deferred payment of an arrearage and is required to pay a deposit as a condition of continuing or resuming service may pay the deposit and arrearage within 120 days in four equal payments, the first of which must be made upon execution of the agreement.

F. APPLICABILITY TO UNPAID ACCOUNTS

Deposits and interest prescribed herein are applicable to unpaid bills owing to the Company when service is discontinued or terminated, or in the event the customer declares bankruptcy or becomes otherwise insolvent.

<p>Issued: December 31, 2018</p> <p>Effective: January 1, 2019</p> <p>Advice Letter No.:</p>	<p>Issued by Justin Lee Brown Senior Vice President</p>	
--	---	--

RULE NO. 13

DEPOSITS
(Continued)

G. RETURN OF DEPOSITS

1. Upon discontinuance or termination of service, the Company will refund any balance of the deposit in excess of unpaid bills.
2. After a residential customer has, for 12 consecutive months, paid bills for service timely, the Company shall refund the deposit with interest thereon.
3. After a nonresidential customer has, for 24 consecutive months, paid bills for service without a delinquent payment, the Company shall refund the deposit with interest thereon. The Company shall implement this procedure by utilizing a customer's payment history for the first 24 month period occurring subsequent to the effective date of such procedure.

H. INTEREST ON DEPOSITS

The Company will pay interest on deposits to be computed and paid in the manner as set forth in NRS 704.655, from the date of deposit until the date of settlement or withdrawal of deposit. Where such deposit remains for a period of one year or more and the person making the deposit continues to be a customer, the interest on the deposit at the end of the year shall be applied to the depositor's account. At the depositor's request, the interest may be paid in cash.

I. WAIVER OF DEPOSITS

1. The Company shall waive the deposit required for residential service under Rule No. 12 if the applicant:
 - a. Has established satisfactory credit with the Company;

<p>Issued: December 31, 2018</p> <p>Effective: January 1, 2019</p> <p>Advice Letter No.:</p>	<p>Issued by Justin Lee Brown Senior Vice President</p>	
--	---	--

RULE NO. 13

DEPOSITS
(Continued)

I. WAIVER OF DEPOSITS (Continued)

1. (Continued)

- b. Has been a customer of a municipal or any other regulated energy utility within the preceding two years and has made timely payment of each bill issued for service during the 12 months immediately preceding the applicant's request for service;
- c. Uses a guarantor with satisfactory credit; or
- d. Receives benefits from a retirement plan or the Social Security Administration and has established satisfactory credit.

- 2. The Company, in determining whether to waive the deposit required for residential service, may consider the payment history, if the previous service was not in the name of the applicant, or if the applicant is newly divorced or separated and is seeking service in the applicant's own name.
- 3. The Company shall provide, at the request of a customer, a form to request credit history from another utility.
- 4. The Company may require a customer who has been granted a waiver of deposit to provide a deposit once unsatisfactory credit has been established.

Issued:
December 31, 2018

Effective:
January 1, 2019

Advice Letter No.:

Issued by
Justin Lee Brown
Senior Vice President

T
T
T

T

RULE NO. 14

DISPUTED BILLS

- A. In the event of a dispute between a customer and the Company as to any bill, charge or service, the customer shall deposit with the Company the amount of the questioned portion of the bill, unless the Company agrees to waive the requirement at the request of the Consumer Relations Division of the Commission. All subsequent bills must be paid to the Company when due.

Any controversy or claim arising out of or relating to this Tariff, or breach thereof, shall be adjudicated by the Commission. This includes, but is not limited to, controversies or claims involving meter errors, billing errors, invoicing errors, and claims for a full or partial refund. This also includes, but is not limited to, service complaints, such as claims arising out of or relating to the establishment, interruption, resumption, or termination of service.

- B. The Company shall promptly investigate the matter and report its determination to the customer in writing, if the customer so requests.
- C. The Company shall inform the customer of the right to file a complaint with the Consumer Relations Division of the Commission if the customer is not satisfied with the determination made by the Company.
- D. Failure on the part of the customer to deposit the disputed amount after due notice may warrant terminating service to such customer without further notice. Notice to the Company by the customer that a bill is disputed shall not serve to extend the time for payment or deposit of disputed amount thereof.
- E. A summary of the provisions of this rule shall be printed on the back of each bill or notice issued by the Company, which shall include the mailing address, telephone number and toll-free telephone number of the Consumer Relations Division of the Commission.

<p>Issued: December 31, 2018</p> <p>Effective: January 1, 2019</p> <p>Advice Letter No.:</p>	<p>Issued by Justin Lee Brown Senior Vice President</p>	
--	---	--

N
N

T

RULE NO. 15

TEMPORARY SERVICE

A. ESTABLISHMENT OF TEMPORARY SERVICE

The Company may furnish temporary service under the following conditions if no undue hardship or shortage of gas supply to its existing customers will result therefrom:

1. The applicant will be required to pay to the Company, in advance, the net estimated cost of installing and removing the facilities necessary for furnishing the desired service.
2. Where the duration of service is to be less than one month, the applicant will also be required to advance a sum of money equal to the estimated total bill for the service. If this advance exceeds the actual bill when known, the excess will be returned to the applicant; if it is less than the actual bill, a bill for the deficit will be presented for payment.
3. Where the duration of service is to exceed one month, the applicant will also be required to establish credit in the manner prescribed in Rule No. 12.

B. CHANGE TO PERMANENT STATUS

If a customer has operated for 36 consecutive months the equipment for which service was originally established on a temporary basis and customer's operations at the end of that time have proven their permanency to the satisfaction of the Company, the payment made pursuant to Section A.1 herein will be adjusted to the terms of the mains and/or service extension rules applicable to permanent service.

<p>Issued: December 31, 2018</p> <p>Effective: January 1, 2019</p> <p>Advice Letter No.:</p>	<p>Issued by Justin Lee Brown Senior Vice President</p>	
--	---	--

RULE NO. 16

FACILITIES ON CUSTOMER'S PREMISES

A. METERS AND APPLIANCES

1. All meters, regulators, service pipe, appliances, fixtures, etc., installed by the Company upon the customer's premises for the purpose of delivering gas to the customer shall continue to be the property of the Company and may be repaired, replaced or removed by the Company at any time.
2. In the cases of residential and commercial customers, metering and regulating equipment required by the Company to render service will be constructed and installed at the expense of the Company provided the total estimated cost of the equipment, less any cash or non-cash contribution in aid of construction (contribution) does not exceed the allowable investment (except as specified in Rule No. 9.A.12). In the cases of all other customers, each customer will be required to make a nonrefundable advance to the Company equal to the full cost of constructing and installing such regulating, metering and safety equipment as determined by the Company.
3. No rent or other charge whatsoever will be made by the customer against the Company for placing or maintaining said meters, regulators, service pipe, appliances, fixtures, etc., upon the customer's premises. All meters will be sealed or soldered by the Company, and no such seal or solder shall be tampered with or broken except by a representative of the Company appointed for that purpose. The customer shall exercise reasonable care to prevent the meters, regulators, service line, appliances, fixtures, etc., of the Company upon said premises from being injured or destroyed and shall refrain from interfering with the same and, in case any defect therein or damage thereto shall be discovered, the customer shall promptly notify the Company thereof.
If damage occurs to the Company's facilities because of the customer's failure to use reasonable care or failure to request from the Company a service line location, the customer will be billed for subsequent repairs.
4. The Company will not be responsible for the loss of gas or damage or injury caused by gas in or escaping from piping or appliances beyond the Company's meter.

<p>Issued: December 31, 2018</p> <p>Effective: January 1, 2019</p> <p>Advice Letter No.:</p>	<p>Issued by Justin Lee Brown Senior Vice President</p>	
--	---	--

RULE NO. 16

FACILITIES ON CUSTOMER'S PREMISES
(Continued)

B. METER INSTALLATION

1. All meters will be installed by the Company in some convenient and safe place approved by the Company upon the customer's premises and so placed as to be at all times accessible for inspection, reading and testing. The Company will change the meter location on customer's premises for reasonable cause, but when such request is made solely to suit the customer's convenience or to overcome an unsafe condition, a charge to the customer will be made to cover the actual cost of the change.
2. In all buildings in which separate meters are hereafter required to be installed for various floors or groups of rooms in order to measure the gas supplied to each tenant, the Company may require all meters to be located at a central point, and each such meter will be clearly marked to indicate the particular location supplied by it.

Issued:
December 31, 2018

Effective:
January 1, 2019

Advice Letter No.:

Issued by
Justin Lee Brown
Senior Vice President

D

T

RULE NO. 16

FACILITIES ON CUSTOMER'S PREMISES
(Continued)

B. METER INSTALLATION (Continued)

4. The Company will place the meter in a location that does not result in the creation and installation of a Primary COYL at the time of the service installation, absent justifying circumstances. Justifying circumstances include, but are not limited to, field conditions, property rights, and large residential, commercial and industrial customers that require the installation of a Primary COYL at the time of the service installation. Prior to the installation of a Primary COYL, the Company will document and verify the circumstances that justify the installation of a Primary COYL. If the installation of a Primary COYL is necessary to provide service, the Company will provide the customer with documentation (as referenced in 49 CFR 192.16) outlining the risks associated with the operation of a Primary COYL, notify the customer of their responsibility for the maintenance of a Primary COYL, and require the customer to sign an acknowledgement indicating receipt of such documentation. After requesting and acknowledging the installation of a Primary COYL, a customer who elects to have the Primary COYL replaced at a future date will be responsible for the associated replacement costs.

Issued:
December 31, 2018

Effective:
January 1, 2019

Advice Letter No.:

Issued by
Justin Lee Brown
Senior Vice President

RULE NO. 16

FACILITIES ON CUSTOMER'S PREMISES
(Continued)

C. COMPANY EASEMENTS AND RIGHTS OF INGRESS AND EGRESS

1. Upon application for gas service and the establishment of service pursuant thereto, and upon the taking of service at any time thereafter, the customer shall be deemed to grant to the Company and its successors and assigns, to whatever extent the customer may be empowered to make such grant, a perpetual easement and irrevocable license for the installation and maintenance of a gas pipeline or pipelines and appurtenances, across, over, under, and through the Customer's premises, together with the rights of ingress and egress and any temporary easements reasonably necessary to install, maintain, or replace the Company's gas facilities. The terms of the grant are such that the Company may, in conjunction with Rule 16(A)(1), relocate its gas facilities and the easement and license to a different location on the premises in order to continue to provide service to the customer or customers served by the Company's gas facilities, and are such that the Company has the right (but not the obligation) to remove any or all of its gas facilities installed on the customer's premises at any time after the termination of service. Any such grant from the owner of the premises served shall be deemed to be an easement and license running with the land and shall bind the owner's successors and assigns.

2. If the Customer is currently receiving service, then within ten (10) days of the Company's request, the customer shall provide, without cost to the Company, a non-exclusive perpetual easement in a form and upon terms that are satisfactory to the Company for the installation and maintenance of a gas pipeline or pipelines and appurtenances, across, over, under, and through the Customer's premises, together with rights of ingress and egress and any temporary easements that are reasonably necessary for the Company to install, maintain, or replace the Company's gas facilities. If the customer is not the property owner, then the customer shall secure such easement from the property owner. The Company may request such an easement whenever it determines that its existing easement or other property rights are unsatisfactory.

<p>Issued: December 31, 2018</p> <p>Effective: January 1, 2019</p> <p>Advice Letter No.:</p>	<p>Issued by Justin Lee Brown Senior Vice President</p>	
--	---	--

L/T
N
L/N
N
N
L
T

RULE NO. 16

FACILITIES ON CUSTOMER'S PREMISES
(Continued)

C. COMPANY EASEMENTS AND RIGHTS OF INGRESS AND EGRESS (Continued)

An easement or other property rights may be unsatisfactory if, among other things, it burdens the Company with undue costs (including costs related to indemnification, insurance, or the maintenance and restoration of the burdened estate); fails to provide a safe, convenient, and economical means for the placement, operation, or access to the Company's gas facilities; seeks to confer benefits for the customer that are unjust, unreasonable, unjustly discriminatory, or preferential; is vague or ambiguous; or conflicts with this Tariff or with the Commission rules and regulations.

3. The Company shall at all times have the right of ingress to and egress from the customer's premises at all reasonable hours for any purpose reasonably connected with the furnishing of gas and the exercise of any and all rights secured to it by law or this Tariff
4. The Company shall have the right (but not the obligation) to remove any or all of its property installed on the customer's premises at any time after the termination of service.

<p>Issued: December 31, 2018</p> <p>Effective: January 1, 2019</p> <p>Advice Letter No.:</p>	<p>Issued by Justin Lee Brown Senior Vice President</p>	
--	---	--

L/T
N
N
L
T
L
L
T

RULE NO. 16

FACILITIES ON CUSTOMER'S PREMISES
(Continued)

D. CUSTOMER'S RESPONSIBILITY FOR EQUIPMENT FOR RECEIVING GAS

The customer shall, at the customer's sole risk and expense, furnish, install and keep in good, safe, and leak free condition all regulators, gas piping, appliances, alarms, fixtures and apparatus of any kind or character located beyond the point of delivery which may be required for receiving gas from the Company and for applying and utilizing gas, including all necessary protective appliances and suitable housing therefore; the Customer will be solely responsible for any injury, damage or loss resulting from the gas, or its use loss, after such gas passes beyond the point of delivery, and the Company shall not be responsible for any loss, injury or damage occasioned or caused by the negligence or wrongful act of the Customer or any of the Customer's agents, employees or licensees in installing, maintaining, using, operating or interfering with any such regulators, gas piping, appliances, alarms, fixtures or apparatus. The Company has the right, but not the responsibility to refuse service to any Customer or discontinue service with or without notice if, in the Company's opinion, the facilities beyond the point of delivery are unsafe or present a hazardous condition.

E. SERVICE CONNECTIONS MADE BY COMPANY'S EMPLOYEES

Only duly authorized employees or agents of the Company are allowed to connect the service pipe to, or disconnect the same from, the Company's gas facilities, or to turn on the supply of gas from the meter. When turning on the supply of gas, the Company shall perform a leak check at the Company's standard delivery pressure of the customer piping and appliances connectors. If any uncontrolled hazardous leakage exists at the time of turn-on, service will be denied until the customer has eliminated all leaks. Except as provided in this Rule, the Company has no duty to inspect, maintain, or repair the customer's premises and has no duty to warn of any condition it observes thereon; the Company shall not be liable for any failure to inspect, maintain, or repair the customer's premises or for the failure to warn of any condition.

<p>Issued: December 31, 2018</p> <p>Effective: January 1, 2019</p> <p>Advice Letter No.:</p>	<p>Issued by Justin Lee Brown Senior Vice President</p>	
--	---	--

RULE NO. 16

FACILITIES ON CUSTOMER'S PREMISES
(Continued)

F. EXCESS FLOW VALVE AND SERVICE LINE SHUT-OFF VALVE

An Excess Flow Valve or Service Line Shut-Off Valve shall be installed in accordance with Rule No. 9 of this Nevada Gas Tariff.

<p>Issued: December 31, 2018</p> <p>Effective: January 1, 2019</p> <p>Advice Letter No.:</p>	<p>Issued by Justin Lee Brown Senior Vice President</p>	
--	---	--

RULE NO. 17

METER TESTS AND ADJUSTMENT OF BILLS

A. TESTS

1. A customer may, upon reasonable notice, require the Company to test the meter used to measure the customer's requirements.
2. No charge will be made for performing a test once during any 12 month period. The Company may charge the customer an amount, as set forth in the Statement of Rates of this Nevada Gas Tariff, for any additional test conducted during that period, which charge shall be refunded if the meter is found to be inaccurate by more than two percent fast.
3. The customer and/or a qualified representative of the Commission may be present at the time a test is conducted.
4. The Company shall, within a reasonable time after a test, provide the customer with a written statement of the results of the test, which shall include notifying the customer if the meter has been replaced or repaired.
5. The Company shall maintain a record of the results and action taken of each test conducted, which shall include the name and address of the customer requesting the test, type and identification number of the meter, type of test and date test was conducted.

B. ADJUSTMENT OF BILLS

1. Meter Error

- a. Fast Meters. When, upon test, any meter is found to be registering more than two percent fast, the amount of the overcharge shall be credited to the customer's account no later than 30 days after the overcharge is determined based on corrected meter readings for the period the meter was in use at the customer's premises, but not to exceed the preceding six months, whichever is shorter.

<p>Issued: December 31, 2018</p> <p>Effective: January 1, 2019</p> <p>Advice Letter No.:</p>	<p>Issued by Justin Lee Brown Senior Vice President</p>	
--	---	--

RULE NO. 17

METER TESTS AND ADJUSTMENT OF BILLS
(Continued)

B. ADJUSTMENT OF BILLS (Continued)

1. Meter Error (Continued)

b. Slow Meters. When, upon test, a meter is found to be registering more than two percent slow, the Company may bill the customer for the amount of the undercharge based on corrected meter readings for the period the meter was in use at the customer's premises, but not to exceed the preceding six months in the case of nonresidential service and three months for residential service, whichever is shorter for each class of service. A residential customer shall be permitted to pay this amount over a three month period.

c. Nonregistering Meters.

(1) When, upon test, any meter is found to be nonregistering, the Company may bill the customer for estimated gas usage for a period of three months or the period the meter is known to have been in service, whichever is shorter. If the Company and the customer cannot agree upon the estimated usage for the period in question, the matter may be submitted to the Commission.

(2) Bills for this purpose will be based on the customer's prior requirements, if reliable, taken in connection with subsequent requirements correctly metered and the general characteristics of the customer's operations.

2. Unauthorized Service. If the Company establishes that a meter has been tampered with or that unauthorized use of gas has occurred, the adjustment made by the Company must be calculated for a period not to exceed the most recent six months of usage or the date on which the tampering or unauthorized use began, whichever is greater.

Issued:
December 31, 2018

Effective:
January 1, 2019

Advice Letter No.:

Issued by
Justin Lee Brown
Senior Vice President

RULE NO. 17

METER TESTS AND ADJUSTMENT OF BILLS
(Continued)

C. GENERAL

Anything herein to the contrary notwithstanding, when it is found that the error in a meter is due to causes the date of which can be reliably established, the overcharge or the undercharge will be computed back to but not beyond that date, and no part of the minimum charge will be refunded. When the date cannot be reliably established, or the Company and customer cannot agree, the matter will be resolved under the provisions of Rule No. 14 of this Nevada Gas Tariff.

Issued:
November 10, 2009

Effective:
November 1, 2009

Advice Letter No.:

Issued by
John P. Hester
Senior Vice President

RULE NO. 18

SUPPLY TO SEPARATE PREMISES AND RESALE

A. SEPARATE METERING

Separate premises, though owned by the same customer, will not be supplied through the same meter.

B. OTHER USES OR PREMISES

A customer shall not use gas received from the Company upon other premises nor for other purposes than those specified in the customer's application for service or provided for in the schedule under which service is being taken.

C. RESALE OF GAS

A customer shall not resell gas received from the Company except as specified in this rule. In the event application is made by a customer, i.e., owner, lessee or operator of a master meter facility, as defined in Rule No. 1, for the use of another (hereafter the "second-party user") where said customer/applicant is deemed the originator of gas services for the purpose of resale, applicant shall first demonstrate to the satisfaction of the Company that said applicant is in compliance with all federal, state and local codes as may be applicable to originators of gas service.

At such time as said application is granted, said customer may include the cost of such gas in the rental charge paid by said customer's tenants or second-party users; and further, such gas will be submetered by said customer to second-party users at rates identical to those which the Company would charge if it served the second-party users directly. The current consumer rate schedules will be conspicuously posted at the operator's office. Billings to second-party users will include the following information:

<p>Issued: November 10, 2009</p> <p>Effective: November 1, 2009</p> <p>Advice Letter No.:</p>	<p>Issued by John P. Hester Senior Vice President</p>	
---	---	--

RULE NO. 18

SUPPLY TO SEPARATE PREMISES AND RESALE
(Continued)

C. RESALE OF GAS (Continued)

1. Previous meter reading and date;
2. Present meter reading and date;
3. Amount of consumption in Ccfs or therms; and
4. Amount payable by consumer for gas service.

Should a customer resell gas otherwise than as provided in the foregoing paragraphs, the Company may either discontinue service to the customer, supply gas directly to tenants or second-party users, or apply to the Commission for an order with respect thereto.

The Company shall not be required to master meter gas to any customer of the type hereinabove described where the Company is the owner of the facilities providing individual service to tenants of such customer.

Issued:
November 10, 2009

Effective:
November 1, 2009

Advice Letter No.:

Issued by
John P. Hester
Senior Vice President

RULE NO. 19

SERVICE AGREEMENTS

- A. Service agreements may be required at any time at the option of the Company, but will be required as a condition precedent to service under the following conditions:
1. Where required by provisions contained in a filed rate or other tariff schedule, in which case the term of the agreement will be that specified in such schedule.
 2. Where the building of a main extension or construction of other facilities will be necessary, in which case the terms of the agreement will be as stated in Rule No. 9 of this Nevada Gas Tariff.
 3. Where temporary service is to be supplied under the provisions of Rule No. 15 of this Nevada Gas Tariff in which case the term of the agreement will be of sufficient length to cover the period of contemplated operations.
- B. Each service agreement for gas service will contain the following provisions:
1. This agreement shall, at all times, be subject to the applicable rate schedule and such changes or modifications by the Commission as said Commission may from time to time direct in the lawful exercise of its jurisdiction.
 2. The Company shall at all times have the right of ingress to and egress from the customer's premises at all reasonable hours for any purpose reasonably connected with the furnishing of gas and the exercise of any and all rights secured to it by law or the rules on file with the Commission.

Issued:
December 31, 2018

Effective:
January 1, 2019

Advice Letter No.:

Issued by
Justin Lee Brown
Senior Vice President

RULE NO. 20

EXAMINATION AND TESTING OF LINES AND EQUIPMENT IN MOBILE HOME PARKS

A. DESCRIPTION OF SERVICE

As and when required by the Commission, the Company will examine and test the gas distribution lines and equipment within a mobile home park and shall report the results of the test to the Commission. The Company shall conduct the examination and testing to determine whether any line or equipment is unsafe for service under the safety standards set by its regulations for maintenance, use and operation of gas distribution lines and equipment.

B. LIMITATION OF LIABILITY

The Company is not responsible for the condition of any lines or equipment not owned by it, or for the maintenance or operation thereof. The Company is responsible only for (a) conducting the examination and test specified in Section A herein, (b) reporting accurately the result thereof to the Commission, and (c) promptly executing any order of the Commission directed to the Company in consequence therein.

C. EXAMINATION AND TESTING CHARGE

1. Any examination and testing of gas distribution lines and equipment by the Company pursuant to this rule shall be conducted at the expense of the customer of the Company to whom gas is metered for subdistribution through the lines and/or equipment tested.
2. The Company's charge for examination and testing shall be the total of the time and equipment charges, with appropriate overhead, accumulated according to the standard accounting practices of the Company.

<p>Issued: December 31, 2018</p> <p>Effective: January 1, 2019</p> <p>Advice Letter No.:</p>	<p>Issued by Justin Lee Brown Senior Vice President</p>	
--	---	--

RULE NO. 20

EXAMINATION AND TESTING OF LINES AND EQUIPMENT IN MOBILE HOME PARKS
(Continued)

C. EXAMINATION AND TESTING CHARGE (Continued)

3. The bill for examination and testing performed by the Company pursuant to this rule is due and payable as of the date of presentation. A late charge of five percent on the first \$200 of the bill, plus two percent of any balance above \$200 will be added to the bill if it is not paid within fifteen 15 days of presentation.
4. Nonpayment of a bill for examination and testing performed by the Company pursuant to this rule shall be treated in accordance with Rule No. 6 of this Nevada Gas Tariff.

Issued:
December 31, 2018

Effective:
January 1, 2019

Advice Letter No.:

Issued by
Justin Lee Brown
Senior Vice President

T
T

T